

H.264 series NVR User's installation and operation Manual

Welcome

Thank you for purchasing our NVR!

This manual is designed to be a reference tool for the installation and operation of your system.

Here you can find information about this series NVR features and functions, as well as a detailed menu tree.

Before installation and operation please read the following safeguards and warnings carefully!

Important Safeguards and Warnings

Do not place heavy objects on the NVR.

Do not let any solid or liquid fall into or infiltrate the NVR.

Please brush printed circuit boards, connectors, fans, machine box and so on regularly. Before cleaning the dust please switch off the power supply and unplug it.

Do not disassemble or repair the NVR by yourself. Do not replace the components by yourself.

Environment

Please place and use the NVR between 0°C and 40°C. Avoid direct sunlight. Stay away from heat source.

Do not install the NVR in damp environment.

Do not use the NVR in smoky or dusty environment.

Avoid collision or strong fall.

Please insure the NVR level installation in a stable workplace.

Please install in ventilated place. Keep the vent clean.

Use within the rating input and output scope.

Directory

| | |
|---|----|
| 1 Production Introduction..... | 4 |
| 1.1 Product overview..... | 4 |
| 1.2 Main functions..... | 4 |
| 2 Open-package check and cable connections..... | 6 |
| 2.1 Open-package check..... | 6 |
| 2.2 Hard disk installation..... | 6 |
| 2.3 Audio and video input and output connections..... | 7 |
| 2.3.1 Video input connections..... | 7 |
| 2.3.2 Video output connections and options..... | 7 |
| 2.3.3 Audio signal input..... | 8 |
| 2.3.4 Audio signal output..... | 8 |
| 2.4 Alarm input and output connections..... | 8 |
| 2.4.1 Alarm input port specification..... | 9 |
| 2.4.2 Alarm output port specification..... | 10 |
| 2.4.3 Alarm output port relay parameters..... | 10 |
| 2.5 Speed dome connections..... | 10 |
| 3 Basic operation..... | 12 |
| 3.1 Turn on..... | 12 |
| 3.2 Turn off..... | 12 |
| 3.3 System Login and Add IP cameras..... | 13 |
| 3.3.1 System Login..... | 13 |
| 3.3.2 NVR add IP cameras..... | 13 |
| 3.4 Preview..... | 18 |
| 3.5 Desktop shortcut menu..... | 19 |
| 3.5.1 Main menu..... | 19 |
| 3.5.2 Playback..... | 20 |
| 3.5.3 PTZ control..... | 24 |
| 3.5.4 Color setting..... | 27 |
| 3.5.5 Output Adjust..... | 28 |
| 3.5.6 Logout..... | 28 |
| 3.5.7 Window switch..... | 29 |
| 3.5.8 Add IPC..... | 29 |
| 3.5.9 Preview set..... | 29 |
| 4 Main menu..... | 30 |
| 4.1 Main menu navigation..... | 30 |
| 4.2 Record..... | 32 |
| 4.2.1 Record Config..... | 32 |
| 4.2.2 Playback..... | 33 |
| 4.2.3 Backup..... | 33 |
| 4.3 Alarm Function..... | 34 |
| 4.3.1 Motion Detect..... | 34 |
| 4.3.2 Video Blind..... | 36 |
| 4.3.3 Video Loss..... | 37 |
| 4.3.4 Alarm input..... | 38 |

| | |
|--|----|
| 4.3.5 Abnormal..... | 38 |
| 4.4 System setup..... | 39 |
| 4.4.1 General..... | 39 |
| 4.4.2 Encode setup..... | 40 |
| 4.4.3 Network setup..... | 41 |
| 4.4.4 NetService..... | 42 |
| 4.4.5 GUI Display..... | 47 |
| 4.4.6 PTZ setup..... | 48 |
| 4.4.7 Add IPC..... | 48 |
| 4.4.8 Tour setup..... | 49 |
| 4.4.9 System Time..... | 49 |
| 4.4.10 Video standard..... | 49 |
| 4.4.11 Resolution..... | 49 |
| 4.4.12 Wireless..... | 49 |
| 4.4.13 Color setting..... | 50 |
| 4.4.14 PTZ control..... | 50 |
| 4.5 Advanced..... | 50 |
| 4.5.1 HDD Manage..... | 50 |
| 4.5.2 Account..... | 50 |
| 4.5.3 Online User..... | 52 |
| 4.5.4 TV adjust..... | 52 |
| 4.5.5 Auto Maintain..... | 53 |
| 4.5.6 Restore..... | 53 |
| 4.5.7 Upgrade..... | 53 |
| 4.6 Info..... | 54 |
| 4.6.1 LOG..... | 54 |
| 4.6.2 Version..... | 54 |
| 4.7 Entertainment..... | 55 |
| 4.8 Shut down system..... | 55 |
| 5 FAQ and maintenance..... | 56 |
| 5.1 FAQ..... | 56 |
| 5.2 Maintenance..... | 61 |
| Appendix 1.Remote controller operation..... | 62 |
| Appendix 2.Mouse operation..... | 63 |
| Appendix 3.Hard disk capability calculation..... | 64 |
| Appendix 4.Mobile Connection..... | 65 |

1 Production Introduction

1.1 Product overview

The series NVR is designed specially for security and defence field which is an outstanding digital surveillance product. It introduces embedded LINUX operating system which is more stable. It introduces standard H.264mp video compressed format and G.711A audio compressed format which insures the high quality image, low error coding ratio and single frame playing. It introduces TCP/IP network technology which achieves the strong network communication ability and telecommunication ability.

The series NVR can be used individually or online applied as a part of a safety surveillance network. With the professional network video surveillance software it achieves the strong network communication ability and telecommunication ability.

The series NVR can be applied in the bank, telecom, electric power system, judicial system, transportation, intelligent housing, factory, storehouse, water conservancy and so on.

1.2 Main functions

Real-time surveillance

HDMI, analog interface and VGA interface

surveillance function through monitor or display

Storage

non-working hard disk dormancy processing which is convenient to radiate heat, reduce power and extend the life-span

special storage format which insures the data safety

Compression

real-time compression by individual hard disk which insures the audio and video signal stable synchronization

Backup

through SATA interface and USB interface such as USB equipment, removable hard disk and so on
through net download the files in the hard disk

Playback

individual real-time video recording as well as searching, playback, network surveillance, recording check, downloading and so on

multi-playback mode

zoom at arbitrary region

Net operating

through net tele-surveillance in the real time

tele-PTZ control

tele-recording check and real-time playback

Alarm linkage

multi-route relay alarm output which is convenient for the alarm linkage and light control at the spot

protecting circuits at the alarm input and output interface which protects the main machine from damage

Communication interface

RS485 interface which fulfills the alarm input and PTZ control

standard ethernet network interface which fulfills the telecommuting function

Intelligent operating

mouse action function

fast copy and paste operating for the same setting

2 Open-package check and cable connections

2.1 Open-package check

When you receive the NVR, please check first .

First, please check whether there is any visible damage to the package appearance. The protective materials used for the package of the NVR can protect most accidental clashes during transportation.

Then, please open the box and get rid off the plastic protective materials. Check whether there is any visible damage to the NVR appearance.

At last, please open the machine crust and check the data wire in the front panel, power wire, the connection between the fan power and the main board.

Front panel and rear panel

- ◆ The key function specification in the front panel and the interface specification in the rear panel are in the specification.
- ◆ Please check the product type in the front panel whether is accordant with the product type you order.

The label in the rear panel is very important for the after service. Please protect it carefully. When you contact us for after service, please provide the product type and serial number in the label.

2.2 Hard disk installation

For the first use, please install the hard disk as the following picture.

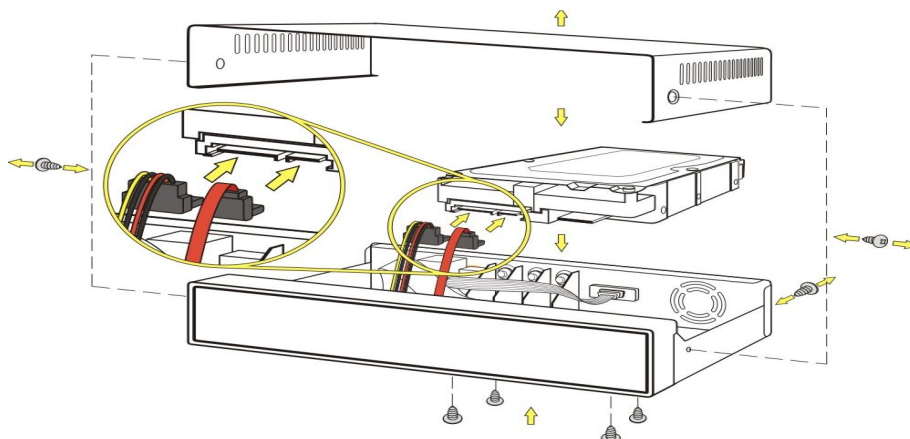

①Connect hard disk

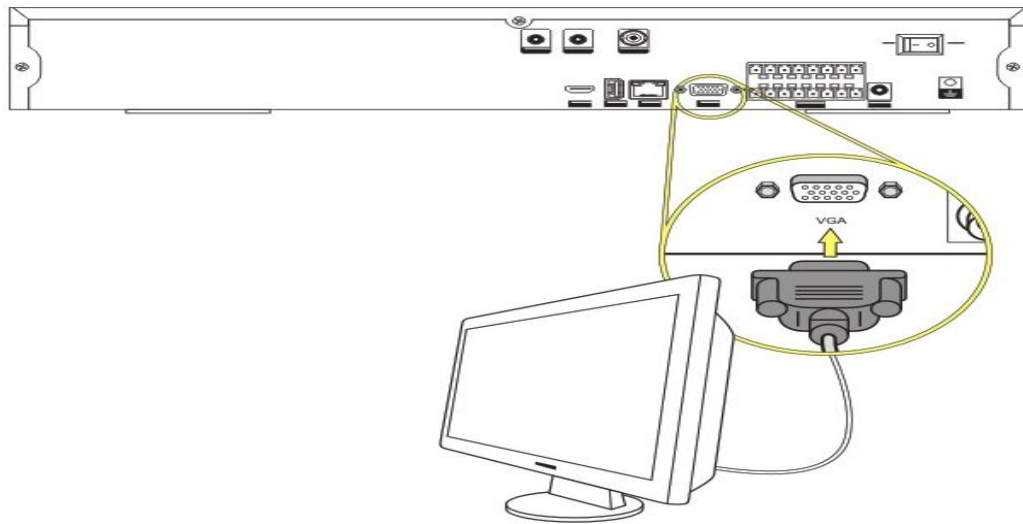

②Connect VGA Output

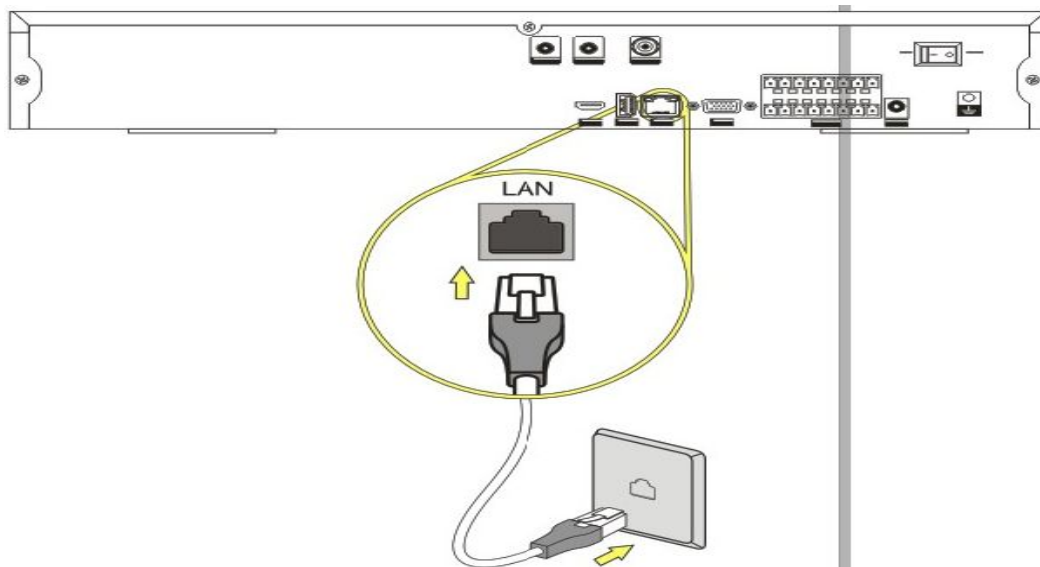

③Connect the network cable

2.3 Audio and video input and output connections

2.3.1 Video input connections

Connect the nvr with network. Search and add IP cameras to nvr. Refer to chapter 3.3.

2.3.2 Video output connections and options

The video output is divided into BNC(1.0V_{P-P},75Ω) ,HDMI output and VGA output(the 3 modes can work at the same time).

When replace the monitor by the computer display, there are some issues to notice.

- 1、 Do not stay in the turn-on state for a long time.
- 2、 Keep the computer display normal working by demagnetizing regularly.
- 3、 Stay away from the electro magnetic Interference.

TV is not a credible replacement as a video output. It demands reducing the use time and control the power supply and the interference introduced by the nearby equipments strictly. The creepage of low quality TV can lead to the damage of other equipments.

2.3.3 Audio signal input

Connect the pickup with audio input interface on IP camera. Then add the ip camera on nvr.

2.3.4 Audio signal output

Commonly the output parameter of NVR audio signal is greater than 200mv 1KΩ(BNC) which can connect the low impedance earphone and active sound box or other audio output equipments through power amplifier.

2.4 Alarm input and output connections

1 、 Alarm input

- A. Alarm input is grounding alarm input.
- B. Alarm input demand is the grounding voltage signal.
- C. When the alarm is connected with two NVRs or connected with NVR and other equipments, it should be isolated by relay.

2 、 Alarm output

Alarm output can not be connected with high-power load(no more than 1A).When forming the output loop it must prevent the big current from relay damage. Use the contact isolator when there is a high-power load

3 、 PTZ decoder connections

- A. The grounding of the PTZ decoder and NVR must be shared otherwise the common-mode voltage will lead to the PTZ control failure. The shielded twisted pair is recommended.
- B. Avoid the entrance of high voltage. Make the layout reasonably. Take precaution from the thunder.

C. In the outlying end connect 120Ω resistance paralleled to reduce the inflection and insure the signal quality.

D. The 485 AB lines of NVR can not connected with other 485 output equipments paralleled.

E. The voltage between the AB lines of the decoder must be less than 5V.

4、Front equipment grounding note

Bad grounding can lead to the burnout of the chip.

5、Alarm input type unlimited

The NVR alarm output port is constant opening type.

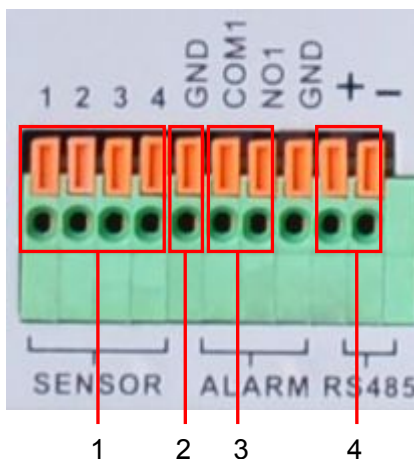

(1) alarm input (2) grounding (3) alarm output (4) RS485

| parameter | meaning |
|-----------|---|
| SENSOR | Alarm input (1、2、3、4) |
| GND | grounding |
| COM1、NO1 | Alarm output interface(constant open type) |
| +、- | 485communication interface which is connected with the recording control equipments such as the decoder |

2.4.1 Alarm input port specification

1 channels alarm input. Alarm input type unlimited.

The grounding and the com port of the alarm sensor are parallel (The alarm sensor is external power supply) .

The grounding of the alarm and the NVR should be shared.

The NC port of the alarm sensor must be connected with the NVR alarm input port.

The grounding of the power supply and the alarm sensor must be shared when used in external power supply.

2.4.2 Alarm output port specification

1 channels alarm output. There is external power supply when using the external alarm equipment.

Please refer to the relay relevant parameters to avoid the overload that damages main machine.

2.4.3 Alarm output port relay parameters

| | | |
|-----------------------------|------------------------|---------------------------------|
| Type: JRC-27F | | |
| Interface material | silver | |
| rating (resistance load) | Rating switch capacity | 30VDC 2A, 125VAC |
| | maximal switch power | 125VA 160W |
| | maximal switch voltage | 250VAC, 220VDC |
| | maximal switch current | 1A |
| isolation | Homo-polarity | 1000VAC 1minute |
| | Inhomo-polarity | 1000VAC 1 minute |
| | Interface and winding | 1000VAC 1 minute |
| Surge voltage | Homo-polarity | 1500VAC (10×160us) |
| Turn-on time | 3ms max | |
| Turn-off time | 3ms max | |
| longevity | mechanical | 50×10 ⁶ MIN (3Hz) |
| | electric | 200×10 ³ MIN (0.5Hz) |
| Environment | -40~+70°C | |

2.5 Speed dome connections

- 1、 Connect the 485 lines of the speed dome with the NVR 485 interface.

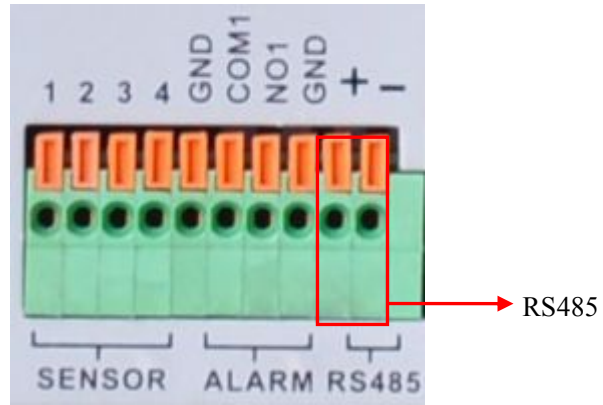

- 2、 Connect the video line with the NVR video input.
- 3、 Electrify the speed dome.

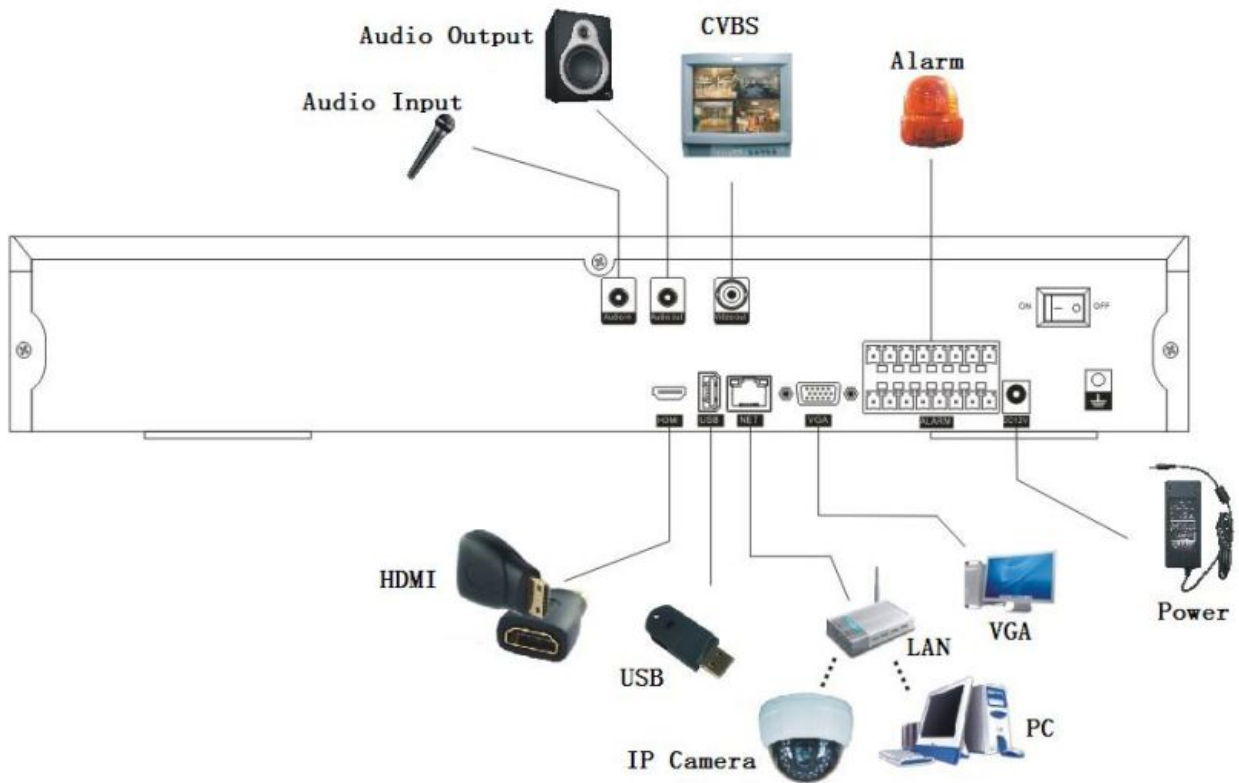

3 Basic operation

Note: The button in gray display indicates nonsupport.

3.1 Turn on

Plug the power supply and turn on the power supply switch. Power supply indicator light shining indicates turning on the video recorder. After the startup you will hear a beep. The default setting of video output is multiple-window output mode. If the startup time is within the video setting time, the timing video recording function will start up automatically. Then the video indicator light of corresponding channel is shining and the NVR is working normally.

Note:1. Make sure that the input voltage corresponds with the switch of the NVR power supply.

2. Power supply demands: 220V±10% /50Hz.

Suggest using the UPS to protect the power supply under allowable conditions.

3.2 Turn off

Press the power supply switch on rear panel to shutdown.

Illumination:

1、 Auto resume after power failure

If the NVR is shut down abnormally, it can automatically backup video and resume previous working status after power failure.

2、 Replace the hard disk

Before replacing the hard disk, the power supply switch in the rear panel must be turned off.

3、 Replace the battery

Before replacing the battery, the setting information must be saved and the power supply switch in the rear panel must be turned off. The NVR uses button battery. The system time must be checked regularly. If the time is not correct you must replace the battery, we recommend replacing the battery every year and using the same battery type.

3.3 System Login and Add IP cameras

3.3.1 System Login

When the NVR boots up, the user must login and the system provides the corresponding functions with the user purview. There is one user settings. The name is **Admin** and has no password. **Admin** is the super user purview. User **Admin**'s password can be revised, while their permissions can't be revised.

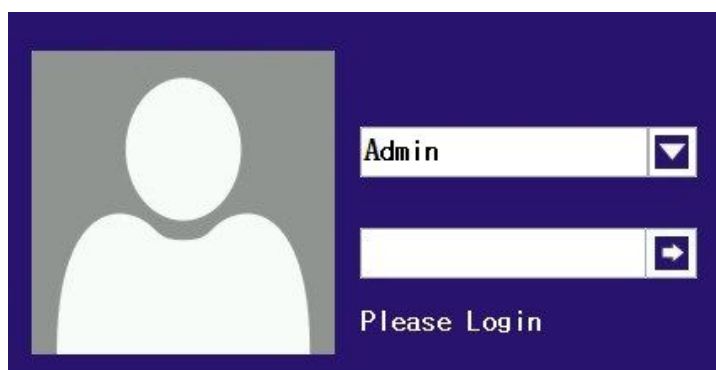

Picture 3.1 System Login

Password protection: If the password is continuous wrong ten times, the account will be locked. (Through reboot or after half an hour, the account will be unlocked automatically).

For your system security, please modify your password after first login.

3.3.2 NVR add IP cameras

(1)To add ip cameras to NVR , please go to "Main Menu -- Add IPC" . NVR will search the ip camras in LAN automatically.Click "ADD" to add the device to the channel list below.Click "OK" to Save after adding devices. You can click "Modify" to change the configuration of the ip cam.

For example,when you setup an ipc with onvif protocol,the IP Address should be in the same network segment with nvr,port uses the searched port,protocol is onvif,resolution/user name/password should be the same as that on ipc.



IP Cam Config

| Index | Protocol | Status | IP Address | Mac Address |
|-------|----------|-----------|---------------|--------------|
| ▶ 1 | GK | Not Added | 172.16.1.88 | 0084149a5c37 |
| 2 | ONVIF | Added | 192.168.1.105 | 0024B632AFB5 |
| 3 | ONVIF | Added | 192.168.1.49 | 0048B4D2783B |
| 4 | GK | Added | 192.168.1.77 | 0084146d8f7c |

Remove Add Add All Update IP

| Channel | Protocol | Resolution | IP Address | Port | User Name |
|---------|----------|------------|---------------|------|-----------|
| ▶ 1 | ONVIF | 720P | 192.168.1.87 | 3737 | admin |
| 2 | ONVIF | 960P | 192.168.1.123 | 80 | admin |
| 3 | ONVIF | 720P | 192.168.1.49 | 80 | admin |
| 4 | ONVIF | 1080P | 192.168.1.81 | 80 | admin |

Delete Modify Manual Move up Move down

IP Cam Config

| | | |
|-------------------|-------------------|---|
| CAM | 13 | > |
| IP Addr | 172 . 16 . 1 . 88 | |
| Port | 6001 | |
| Resolution | AUTO | > |
| Protocol | GK | > |
| User Name | Admin | |
| Password | | |
| remote_CAM | 1 | |

(2)Right click on the preview interface,and click “Add IPC”.

If you click “add ipc” next,nvr will show the ip cameras searched automatically in LAN.Click “Add” ,the selected ipc will be added to current channel.

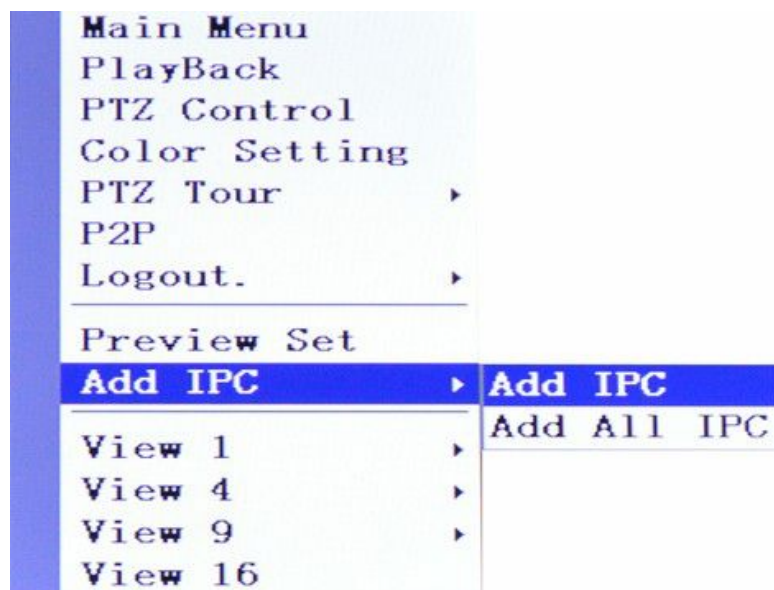

| Index | Protocol | Status | IP Address | Mac Address |
|-------|----------|-----------|--------------|--------------|
| ▶ 1 | ONVIF | Not Added | 192.168.1.32 | 00762A7CE732 |
| 2 | ONVIF | Not Added | 192.168.1.21 | 00FAD9238595 |
| 3 | ONVIF | Not Added | 192.168.1.28 | 00ADDBCBFC9F |
| 4 | ONVIF | Not Added | 192.168.1.19 | 008815ED4411 |
| 5 | ONVIF | Not Added | 192.168.1.20 | 0079730E4BC9 |
| 6 | ONVIF | Not Added | 192.168.1.30 | 00E09BF3A291 |
| 7 | ONVIF | Not Added | 192.168.1.23 | 00D3CAC8489A |
| 8 | ONVIF | Not Added | 192.168.1.22 | 000680907B67 |
| 9 | ONVIF | Not Added | 192.168.1.16 | 002DF912CA75 |
| 10 | ONVIF | Not Added | 192.168.1.17 | 009550320B40 |
| 11 | ONVIF | Not Added | 192.168.1.15 | 00909331BB77 |
| 12 | ONVIF | Not Added | 192.168.1.29 | 000AE6F54C3D |

Remove Add

If you click “Add All IPC”, please select a protocol, then nvr will automatically search and add IP cameras supported this protocol in LAN to all channels.

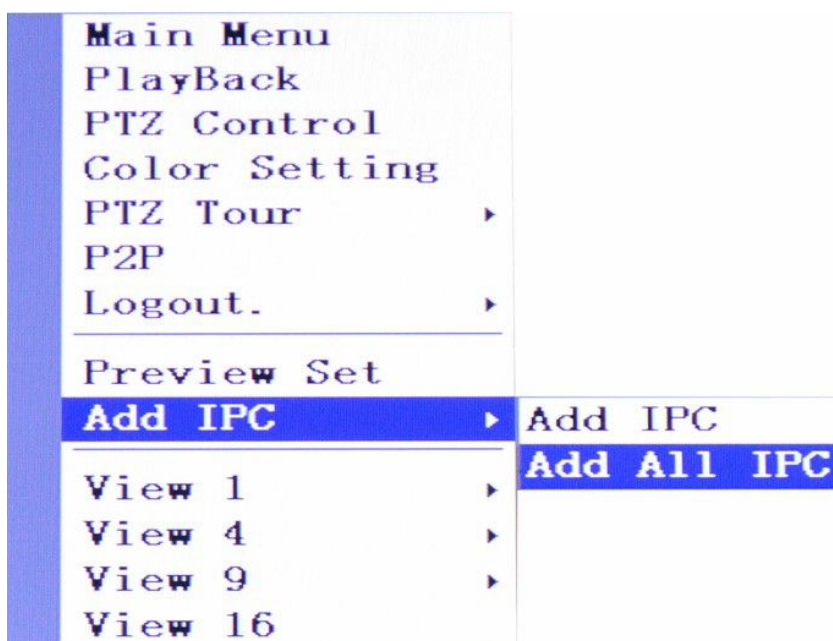

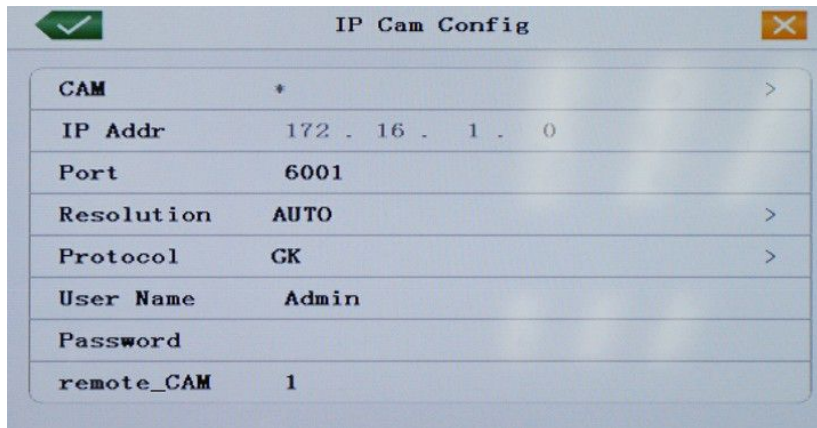

(3)Click “+” in the middle of the channel,nvr will show the ip cameras searched automatically in LAN.Click “Add” ,the selected ipc will be added to current channel.

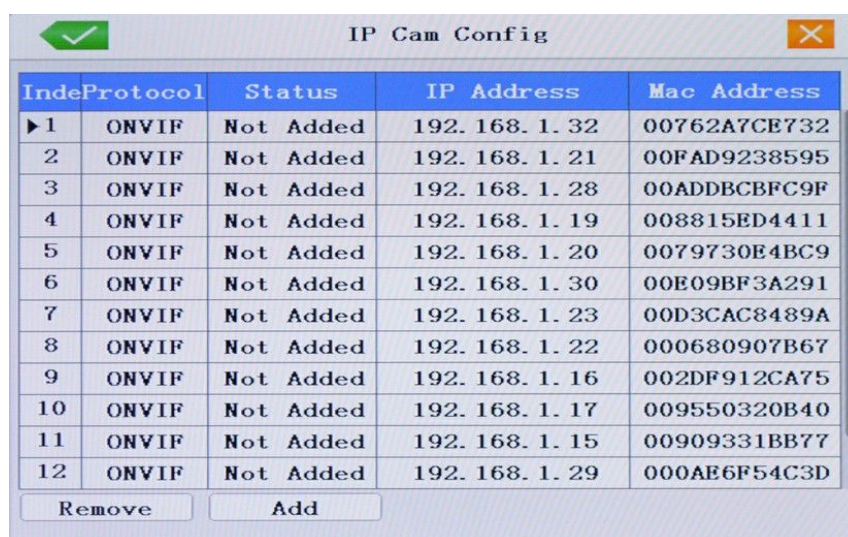
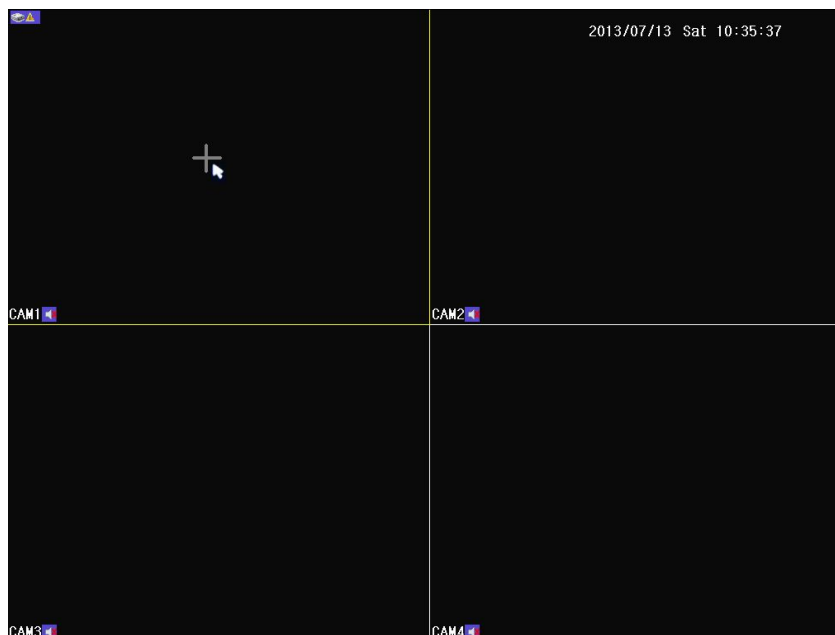

(4)Connect nvr via IE ,click “setup--Device setting--System maintenance--channel mode setup”.Select channel and device,then click “Apply”.Fill in the ipc info on the right and click “Update”.Click “OK” to exit channel mode.You will see the ipc when you return to the preview interface.

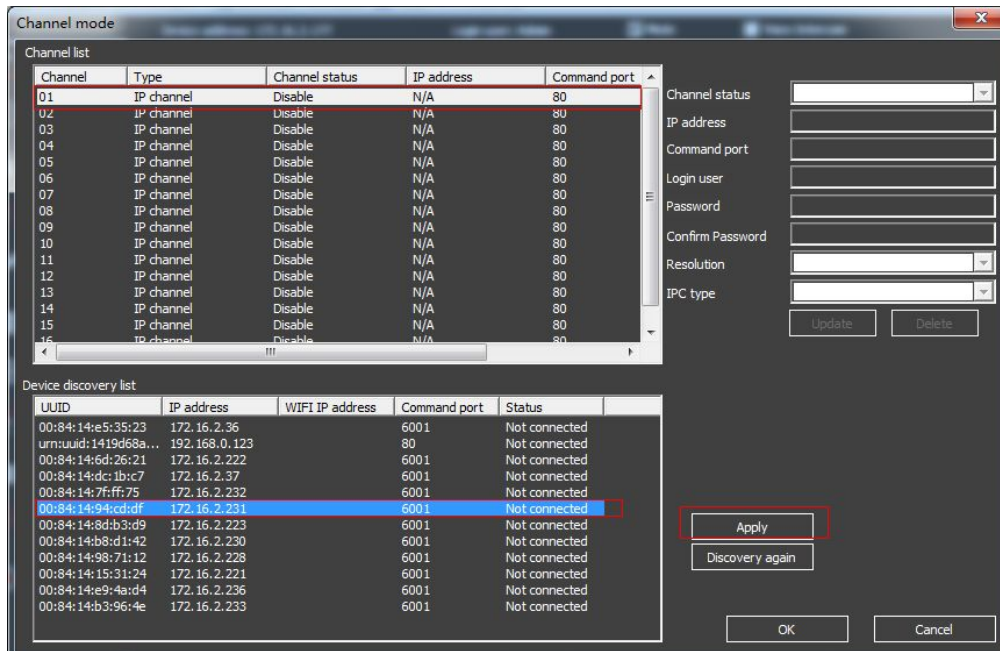
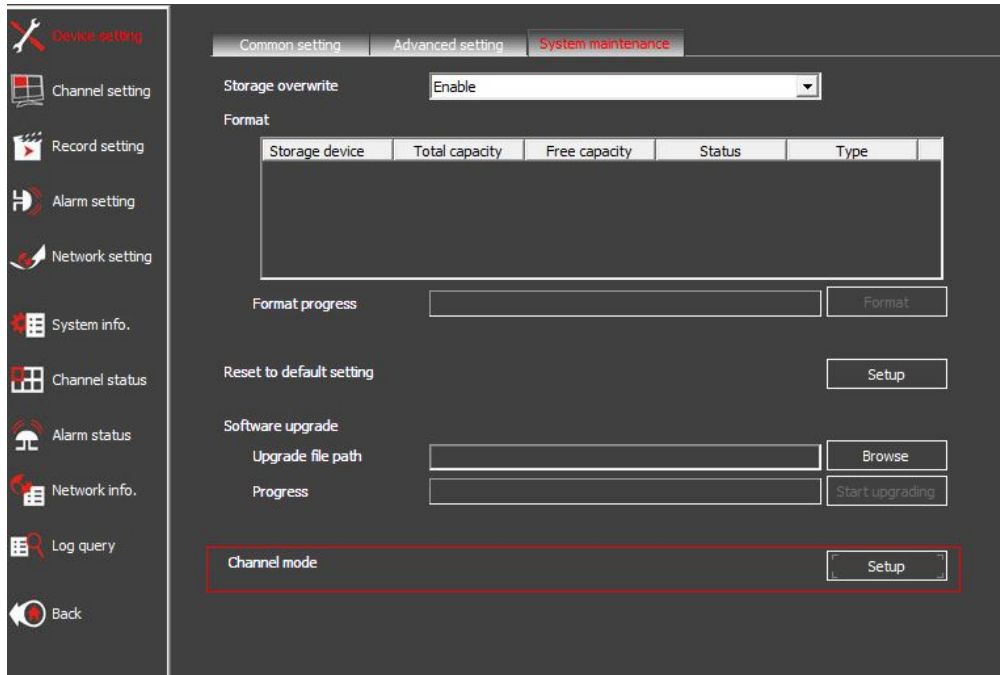

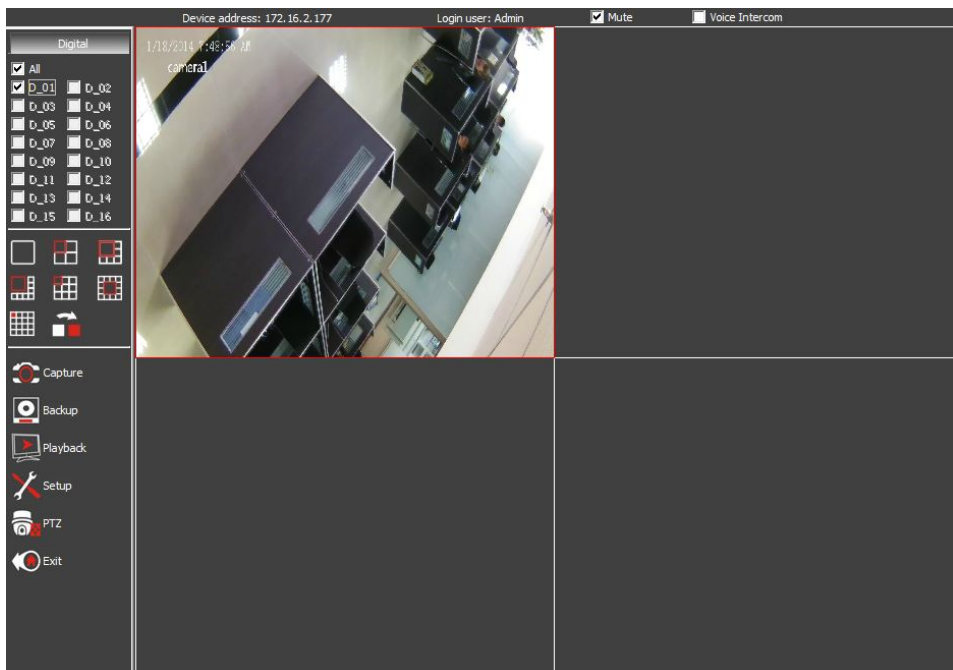
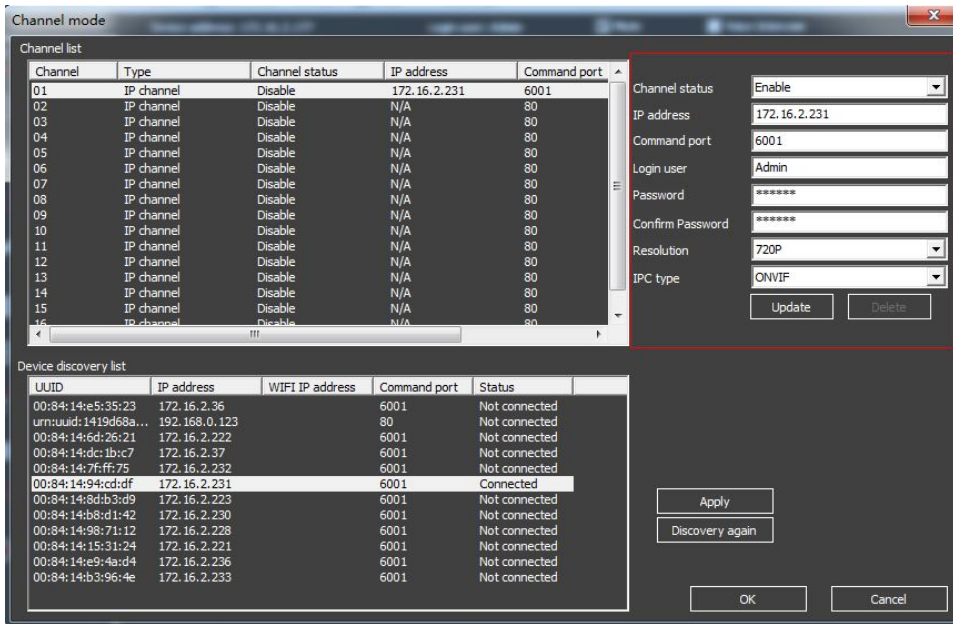

3.4 Preview

You can right click mouse to choose the switch between the windows.

The system date, time and channel name are shown in each viewing window. The surveillance video and the alarm status are shown in each window.





| | | | | | |
|----------|---|------------------|----------|--|-------------|
| 1 |  | Recording status | 2 |  | Video loss |
| 3 |  | Motion detect | 4 |  | Camera lock |

Table 3.1 Preview icon

3.5 Desktop shortcut menu

In preview mode you can right click mouse to get a desktop shortcut menu. The menu includes: **Main Menu, Playback, PTZ Control, Color Setting, Output Adjust, PTZ Tour, P2P, Logout, Preview setup, Add IPC, View1/4/8/9/16 screens.**

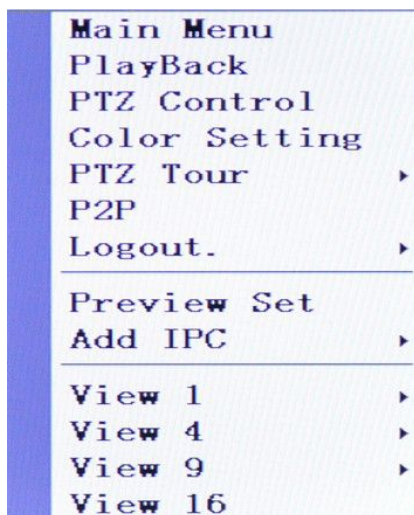

Picture 3.2 Shortcut Menu

At the bottom of the interface, there is a toolbar to quickly access some general settings:



3.5.1 Main menu

When you login, the system main menu is shown as below.

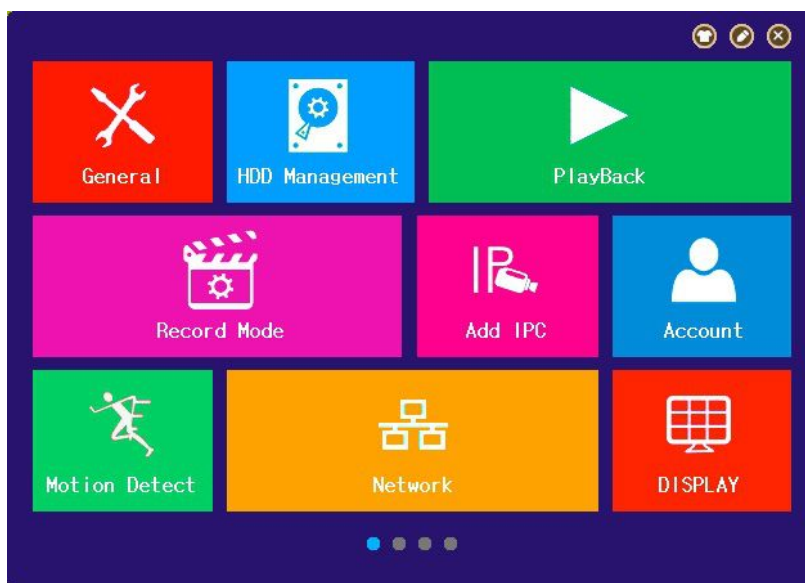



Picture3.3 Main Menu

1.Switch page:3methods to switch pages in main menu:click the color picture on the sides of the main page;press

the left key and slide left or right;click the dots below the main page.

2.Change background:click  to change the background color.

3.Edit:click  to enter edit mode.Items on first page are fixed.Drag items in the main page area to change their positions.Drag items outside the main page area or click  to hide the items.Drag items to the main page area or click  to show them.



4.shutdown: click  shutdown the main menu.

3.5.2 Playback

There are two methods for you to play the video files in the hard disk.

- 1、 In the desktop shortcut menu.
- 2、 Main menu->Playback

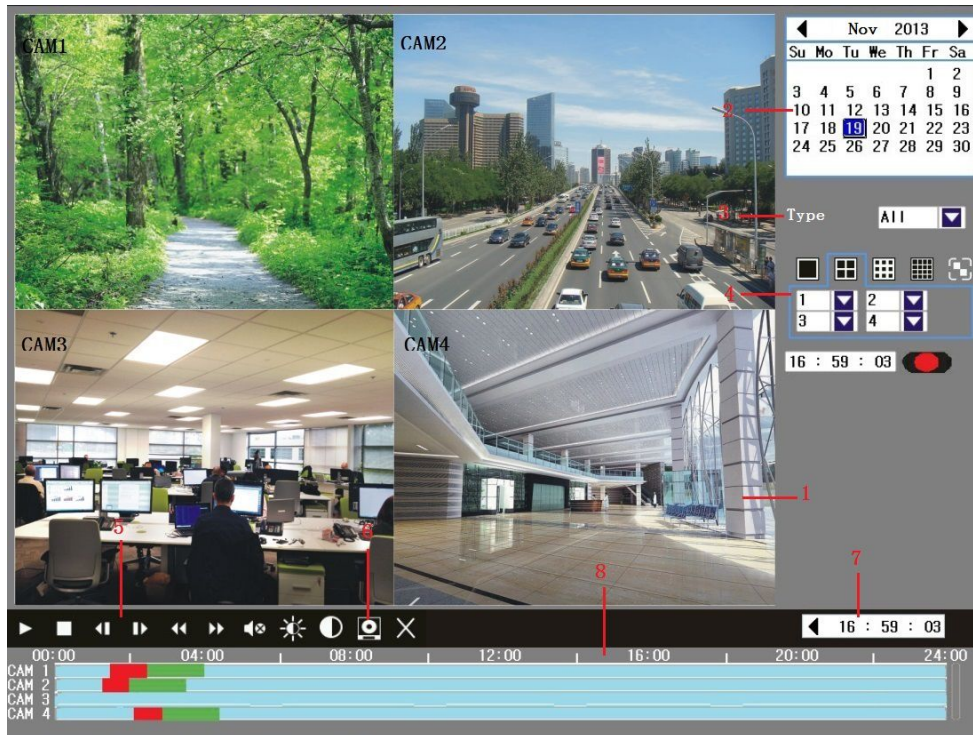

Picture 3.4 video playback

1. record
2. date and time
3. record type
4. channels
5. Playback control
6. files backup
7. speed hint
8. timeline

【Record】 Play files recorded.

【Date and time】 Choose the date and time. Date with white border means the system date. Red background means this day has record files.

【Record type】 Normal, motion detect ,alarm or others.In the video searched,blue means normal ,green means motion,red means alarm.

【Channels】 Choose the channels to display.

【Speed hint】 show the fast or slow playback speed.

【File backup】 Go to backup files. Click the button and operate as followed.

Note: The storage must be installed before the file backup. If the backup is terminated, the already backup can playback individually.

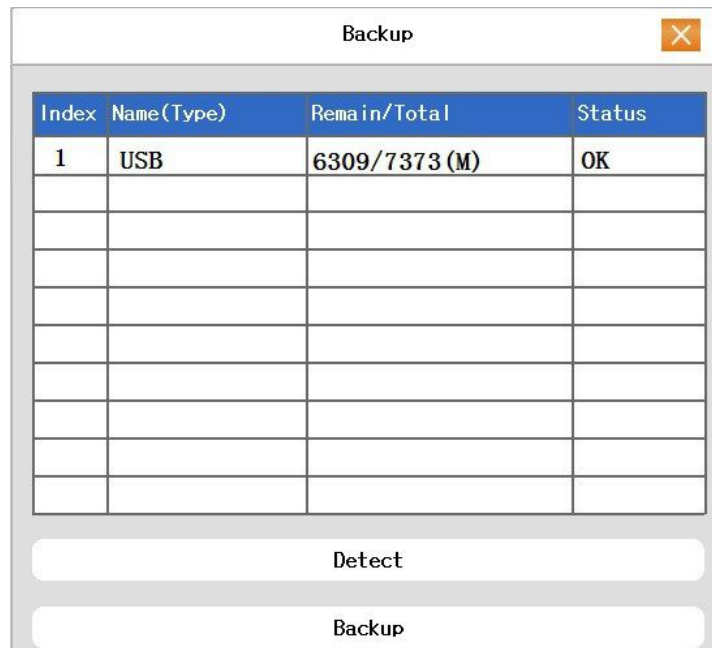

Picture 3.5 detect the storage

Detect: Detect the storage connected with the NVR such as hard disk or universal disk.

Backup: Click backup button and the dialog box is popped up. You can choose the backup file according to the type, channel and time.

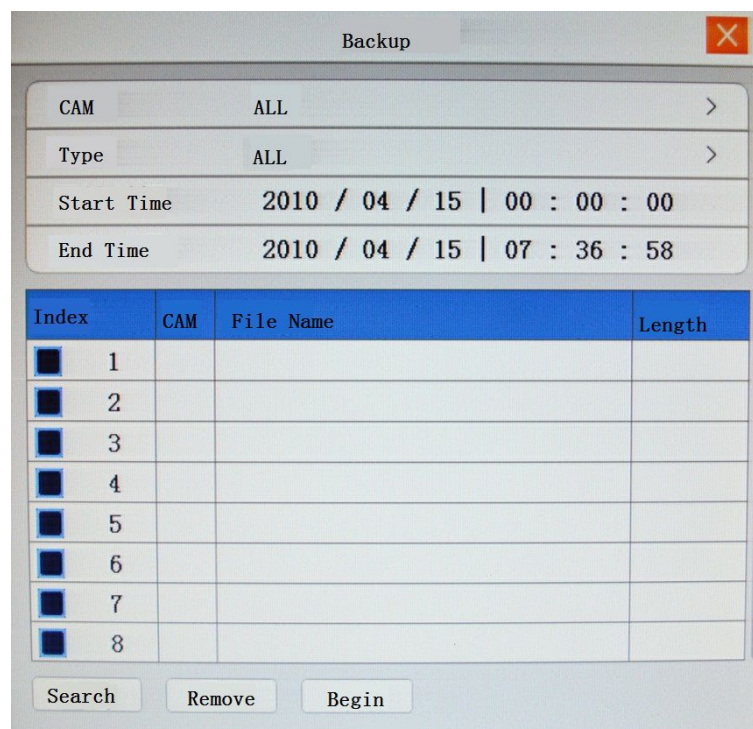

Picture 3.6 recording backup

Remove: Clear the file information.

Search: Search the file according to the searching parameter.

Begin: Click the play button to start the backup

Cancel: During backup you can exit the page layout to carry out other functions.

【File searching】 Search the file according to the searching parameter.

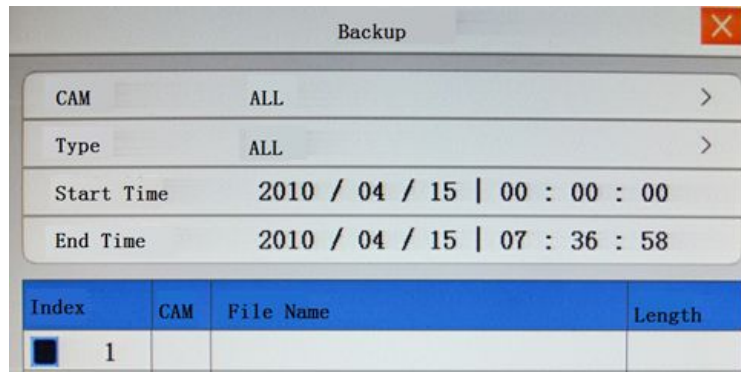

Picture 3.7 file searching

Channel: Set the searching channel.

File type: Set the searching file type.

Start Time: Set the searching time scan.

【Playback control】 Refer to the following sheet for more information.

| Button | Function | Button | Function |
|--------|-------------|--------|----------------|
| | Play/pause | | Exit |
| | Stop | | Slow play |
| | Fast play | | Previous frame |
| | Next frame | | Audio |
| | Brightness | | Contrast |
| | Full screen | | Backup |

Table 3.2 Playback control key

Special functions:

Single channel view: double-click the channel to see the single channel and next double-click to back

Full screen view:click the right key or to see full screen view

Accurate playback : Input time (h/m/s) in the time column and then click

play  button. The system can operate accurate playback according to the searching time.

Local zoom: When the system is in single-window full-screen playback mode, you can drag your mouse in the screen to select a section and then left click mouse to realize local zoom. You can right click mouse to exit.

Zoom timeline: Double-click the left key on timeline bar to see the record in the hour:



3.5.3 PTZ control

Operation interface is as followed. The functions include: PTZ direction control, step, zoom, focus, iris, setup operation, patrol between spots, assistant switch, light switch and so on.

Note1. Decoder A(B)line connects with NVR A(B)line. Make sure the connection is right before use.If PTZ is controled by onvif,please enable"Distance" in device type in [PTZ config].

2. Click [main menu] >[PTZ config] to set the PTZ parameters.
3. The PTZ functions are decided by the PTZ protocols.







Picture 3.8 PTZ setup

【CAM】 Choose the dome camera input channel.

【Speed】 Set the PTZ rotation range. Default range: 1 ~ 8.

【Zoom】 Click /  button to adjust the zoom multiple of the camera.

【Focus】 Click /  button to adjust the focus of the camera .

【Iris】 Click /  button to adjust the iris of the camera.

【Direction control】 Control the PTZ rotation. 8 directions control is supportive.(4 directions in Front panel is supportive)

【High speed PTZ】 Full-screen show channel image. Left press mouse and control PTZ to rotate orientation. Left press mouse and then rotate the mouse to adjust the zoom multiple of the camera. Click “PTZ Trace” to begin.

Special functions:

1、Preset

Set a location for the preset, calls the preset points, PTZ automatically turns to the setting position

1) Preset option

Set a location for the preset, procedure is as follows:

Step 1: in Picture 3.8, click “preset -- modify” to enter preset setting page.

Step 2: Move the PTZ to where you want to set the preset,choose the preset number, then click “set”.The preset point is ok now.

Step 3: repeat step 2 to set other preset points.

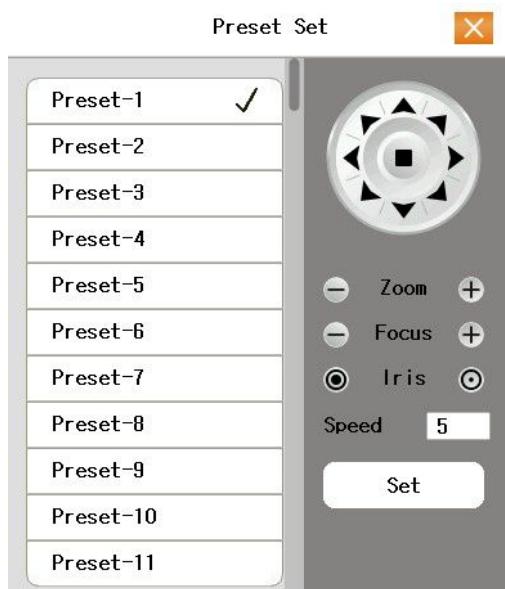

Picture 3.9 Preset Settings

2) Preset Point Calls

In Picture 3.8, click “preset”,choose the preset number , PTZ turn to the corresponding preset point.

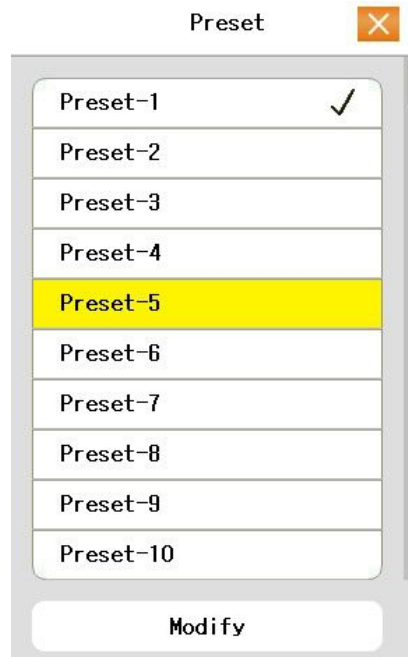

Picture 3.10 PTZ Control

2、Cruise between Points

Multiple preset points connected cruise lines, call cruise between points, the PTZ run around on the line

1) Cruise Between Points Settings

Cruise lines is connected by multiple preset points, setting procedure is as follows:

Step 1: set your preset points .

Step 2: click button "Cruise Line", then write proper value into the Preset Points blank and interval blank, then click button "Add" .

Step 3:click  to save, complete setting.

Remove Preset: click the preset point item in the information box, then click Delete button.The preset point will be removed after that.

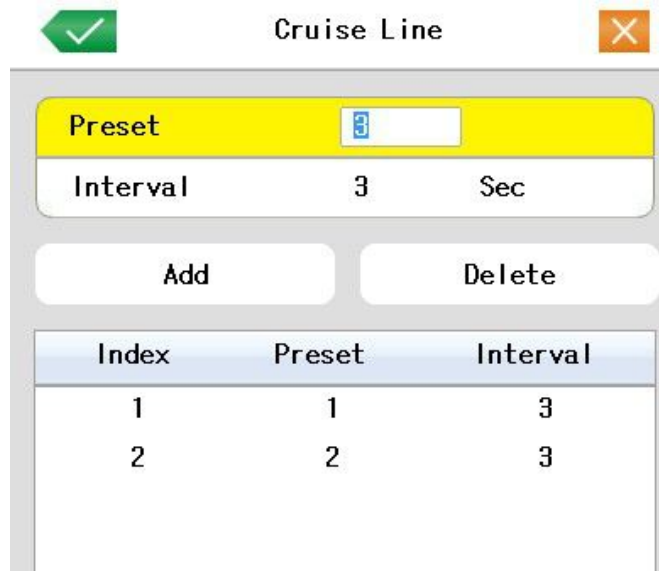

Picture 3.11 Cruise Between Points Settings

2) The Calls of Cruise between Points

Click right key in preview interface, select PTZ tour—start cruise .PTZ begins to work on the cruise line. Click Stop cruise to stop cruise.

You can also click the start/stop button surrounded by direction buttons In Picture 3.8 to start or stop the cruise.

3.5.4 Color setting

Set the selective image parameters (current channel for single window display and cursor place for multi-window display). You can use the desktop shortcut menu and enter the interface. The image parameters include: tonality, brightness, contrast, saturation. You can set different parameters at different time sections.



Picture 3.12 Color Setting

3.5.5 Output Adjust

Adjust TV output area parameters. You can use the desktop shortcut menu or enter [main menu]> [Output adjust].

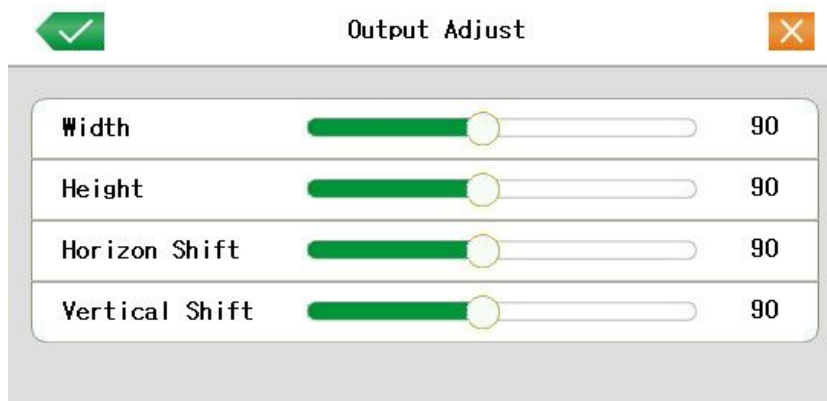

Picture 3.13 Output Adjust

3.5.6 Logout

Logout, shut down the system or reboot up. You can use the desktop shortcut menu or enter [main menu].



Picture 3.14 Logout/Shutdown/Reboot the system

【logout】 Quit the menu. Offer password next entrance.

【shut down】 Quit the system. Turn off the power supply.

When press the shut down button, there is schedule hint. After three seconds, the system is shut down. Cancel midway is of no effect.

【reboot】 Quit the system. Reboot up the system..

3.5.7 Window switch

Preview in single window/four windows/eight windows/nine windows/sixteen windows according to your choice.

3.5.8 Add IPC

Add IPC:Add IPC to the current channel

Add ALL IPC:Add IPC to all channels.For more details,refer to chapter 3.3 NVR add IP Cameras.

3.5.9 Preview set

According to the situation, you can choose the main stream or sub-stream in the preview of each IPC channel.

- (1)if the actual screen-split number is bigger than the setup value, then it display sub-stream
- (2) if the actual screen-split number is smaller than the setup value,and it do not exceed the decoding capabilities, then it display main stream; if it is beyond decoding capabilities, then it shows "resources lack"

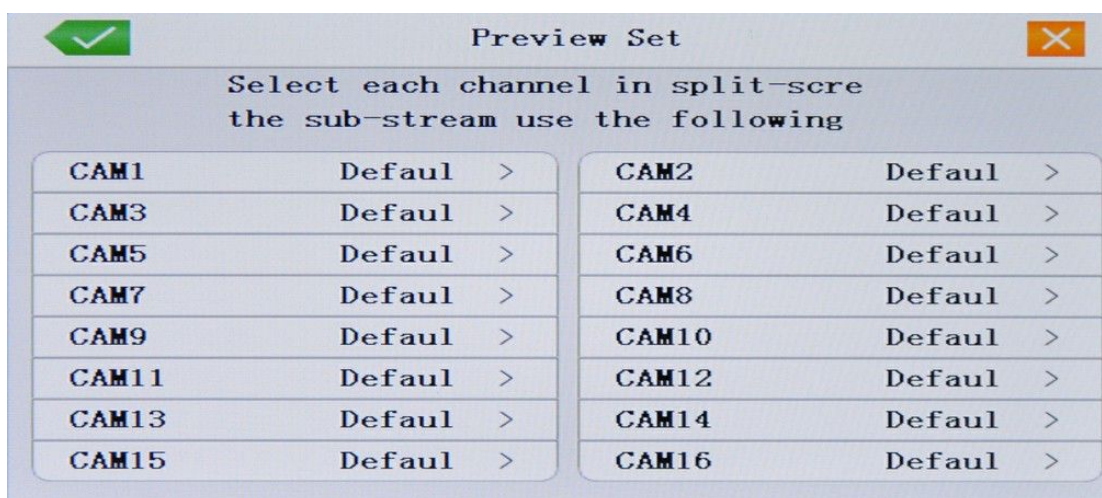

4 Main menu

4.1 Main menu navigation

| Main menu | Sub menu | Function |
|----------------------|-----------------------|--|
| Record | Config | Set the recording configuration, recording type, recording time section |
| | playback | Set recording look-up, recording play, video file storage |
| | backup | Detect backup equipment, backup the selective files |
| Alarm | Motion detection | Set motion detect alarm channel, sensitivity, area, linkage parameters: defending time section, alarm output, screen hint, recording, PTZ, patrol |
| | Video blind | Set camera mask alarm channel, sensitivity, linkage parameters: defending time section, alarm output, screen hint, recording, PTZ, patrol |
| | Video loss | Set video loss alarm channel, linkage parameters: defending time section, alarm output, screen hint, recording, PTZ, patrol |
| | Alarm input | Set alarm input channel, equipment type, linkage parameters: defending time section, alarm output, screen hint, recording, PTZ, patrol |
| | Abnormality | No disk ,disk error,disk no space ,and so on |
| System configuration | General configuration | Set system time, data format, language, hard disk full time operation, machine number, video format, output mode, summertime, stay time |
| | Encode configuration | Set main(assistant)coding parameter: code mode, resolving ability, frame rate, code stream control, image quality type, code stream value, frame between value, video/audio enable |
| | Network configuration | Set basic network parameters, port, DHCP and DNS parameters |
| | NetService | PPPOE、NTP、Email、IP purview、DDNS parameter |
| | GUI display | Set channel name, preview hint icon state, transparency, cover area, time title, channel time fold |

| | | |
|-------------------------|-----------------------|--|
| | PTZ configuration | Set channel, PTZ protocol, address, baud rate, data bit, stop bit, check |
| | IP Cam Config | Search and add ip cameras |
| | Tour | Set patrol mode and interval time |
| | System Time | Set system time |
| | Video Standard | Set video standard |
| | Resolution | Set display resolution |
| | Wireless | Set 3G dial-up connection |
| | Color Setting | Set image color |
| | PTZ Control | Enter ptz control interface |
| Managem ent tools | Hard disk management | Show the state of disks in the NVR , format disk , recover and so on |
| | User management | Modify user or password . Add user . Delete user . |
| | Online user | Break the connection with the already login user. Lock the account after break until booting up again. |
| | TV adjust | Adjust TV upside, downside, nearside, starboard distance |
| | Automatic maintenance | Set automatic reboot system . |
| | Restore | Resume setup state: common setup, code setup, recording setup, alarm setup, network setup, network service, preview playback, serial port setup, user management |
| | Upgrade | to upgrade with external device(such as USB) |
| | Device Info | show quantity information of device interface |
| Info | Log information | Display all log information according to the log video and time |
| | Edition information | Display edition information |

| | | |
|---------------|------------------------|-----------------------------|
| Shut down | Logout/shutdown/reboot | Logout, shut down or reboot |
| Entertainment | Game | Tetris |

4.2 Record

4.2.1 Record Config

Set the recording parameters in the surveillance channel. The system is set 24 hours consecutive recording in the first startup. You can enter [main menu]> [record mode] to set.

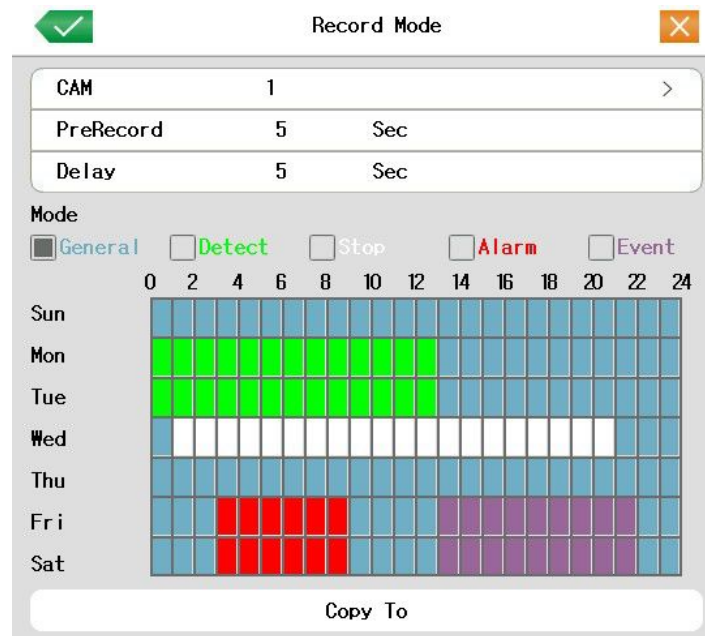

Picture 4.1 Record Config

【CAM】 Choose the corresponding channel number to set the channel. Choose the all option to set the entire channels.

【PreRecord】 Record 1-30 seconds before the action. (time length is decided by the code stream)

【Mode】 Set video state: general, detect, alarm, event, stop.

General: Perform the regular recording in the set time section.

Detect: Trigger the “motion detect”, “camera mask” or “video loss” signal. When above alarm is set as opening recording, the “detection recording” state is on.

Alarm: Trigger the external alarm signal in the set time section. When above alarm is set as opening recording, the “detection recording” state is on.

Event:All record except general record

Stop:The according channel stops recording in the set time section

【 Period 】 Set the time section of common recording, The recording will start only in the set range. First select one of the record mode, then click the left key or drag to select the period.

【 Copy to 】 copy the current channel settings to other channels.

Note: Refer to chapter 4.3 to set corresponding alarm function.

4.2.2 Playback

Refer to chapter 3.5.2.

4.2.3 Backup

You can backup the video files to external storage through setup.

Note: The storage must be installed before the file backup. If the backup is terminated, the already backup can playback individually.

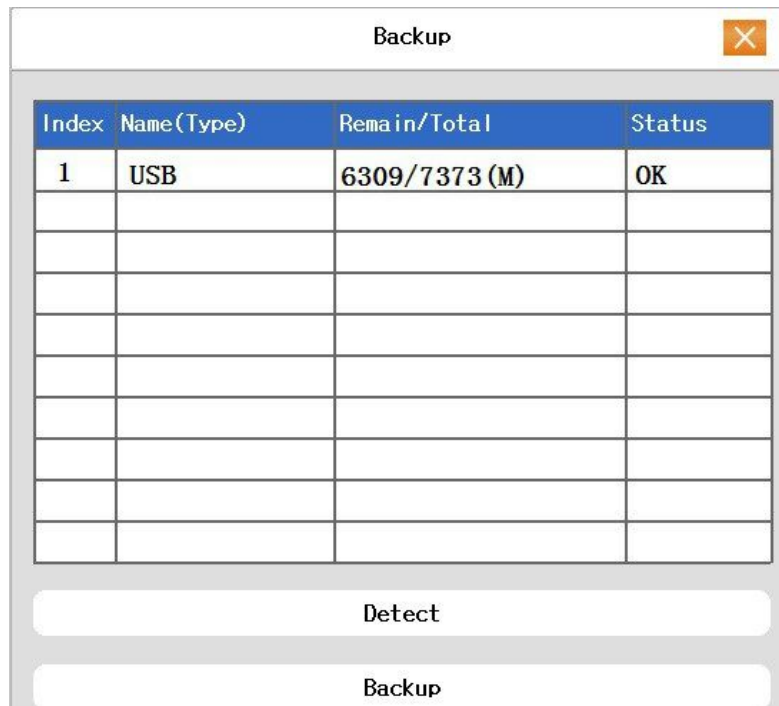

Picture 4.2 Backup

【 Detect 】 Detect the storage connected with the NVR such as hard disk or universal disk.

【 Backup 】 Click backup button and the dialog box is popped up. You can choose the backup file according to the type, channel and time.

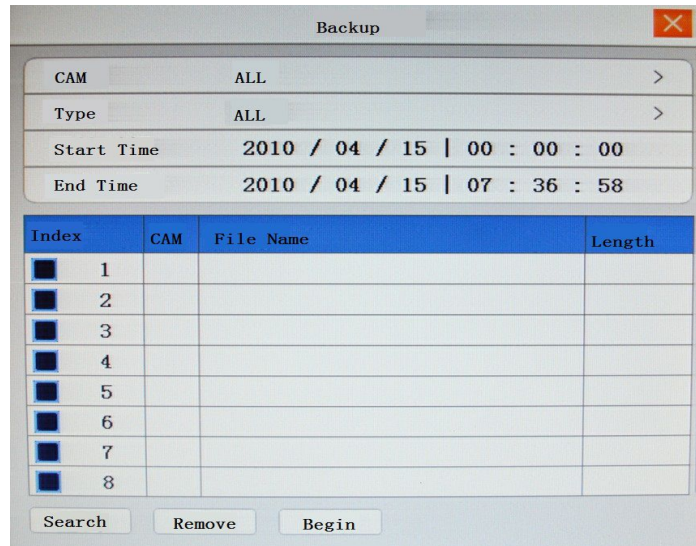

Picture 4.3 File Backup

Query: Show the file information satisfying the set file attributes.

Remove: Clear the file information.

Begin: Click the play button to start the backup.

4.3 Alarm Function

Alarm functions include: motion detect, video loss, alarm input .

4.3.1 Motion Detect

When system detects the motion signal that reaches the set sensitivity, the motion detect alarm is on and the linkage function is turned on.

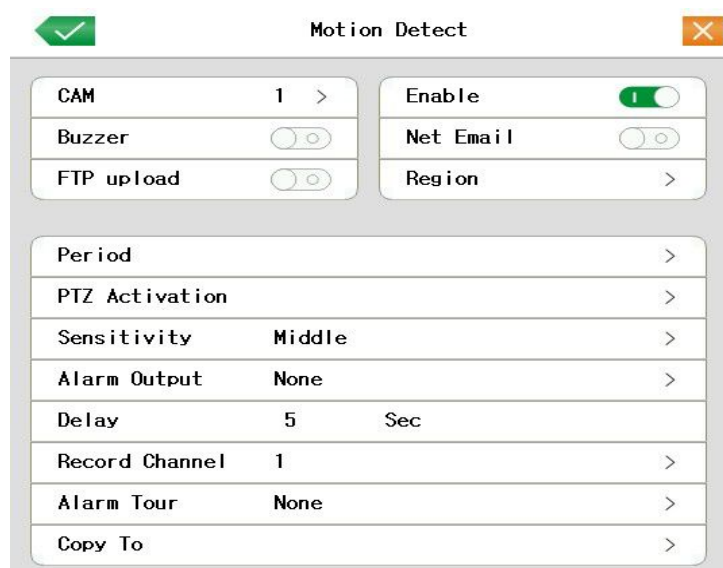

Picture 4.4 Motion Detect

【CAM】 Choose the set motion detect channel.

【Enable】  means that the motion detect function is on.

【Sensitivity】 Choose in the six options according to the sensitivity.

【Region】 Click setup and enter the set area. The area is divided into PAL22X18.. Yellow block means the dynamic detect defensive area. Black block means the unfenced area. You can set the area as followed, Drag the mouse and draw the area.

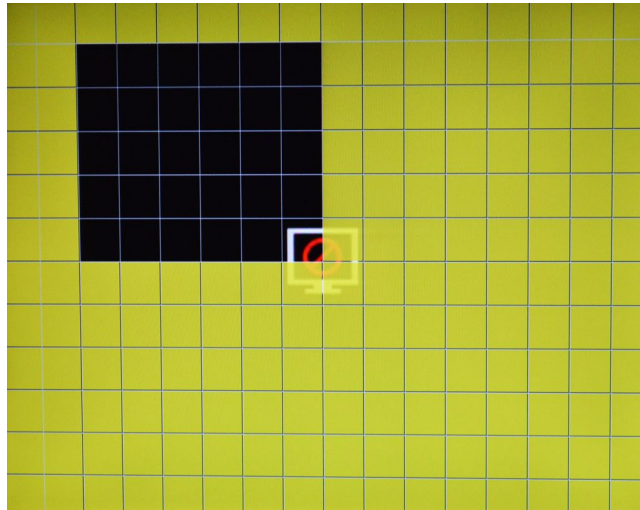

Picture 4.5 Region

【Period】 Trigger the motion detect signal in the set time section. Click the left key of mouse or drag on the time blocks to select period .Yellow means the set valid.

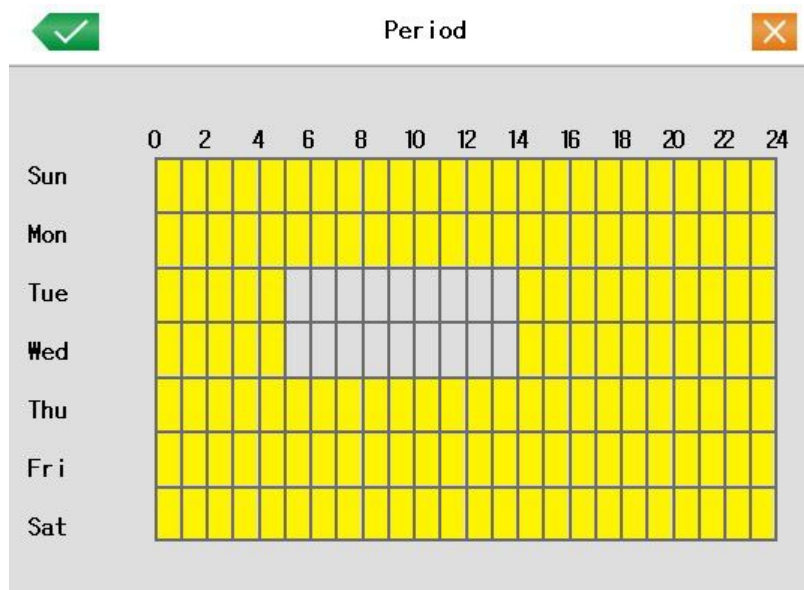

Picture 4.6 set the time section

【Alarm output】Start the external equipment of corresponding linkage alarm when the motion detect

alarm is turned on.

【Delay】 Delay a few moments and stop when the alarm state is turned off. The range is 10~300 seconds.

【Record channel】 Choose the recording channel (multiple option supportive). Trigger the video signal when the alarm is turned on.

Note:Set in the [recording setup] and perform the linkage recording. Start detecting video files in the corresponding time section.

【Tour】 The selective channel is single window alternate patrol preview.The interval is set in the [MainMenu]> [Tour].

【PTZ Activation】 Set the PTZ activation when the alarm is turned on.

Note:PTZ activation is set in the [shortcut menu] >[PTZ control]. Set the patrol between spots, trail patrol and so on.

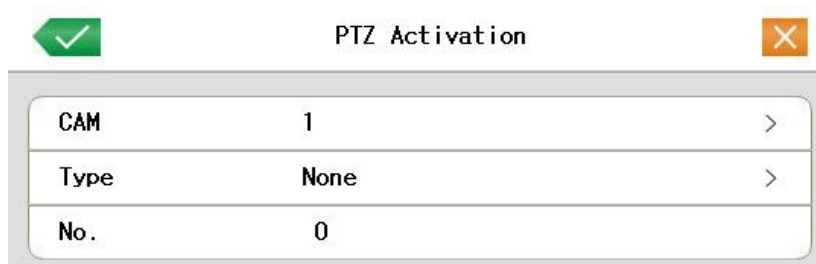

Picture 4.7 PTZ Activation

【Delay】 When alarm is over,recording will last some seconds(10~300sec),then stop.

【Show message】 Pop the alarm information dialog box in the local host computer screen.

【Send EMAIL】 means sending an email to user when the alarm is turned on.

Note:Set in the [NetService] and send email.

【FTP upload】 means upload the alarm images to your ftp when the alarm is turned on.

【Buzzer】 Device buzzers when NVR detects alarm .

4.3.2 Video Blind

When the video image is influenced by the environment such as bad brightness or reaching the set sensivity parameter, the camera mask function is turned on and the linkage function is turned on.

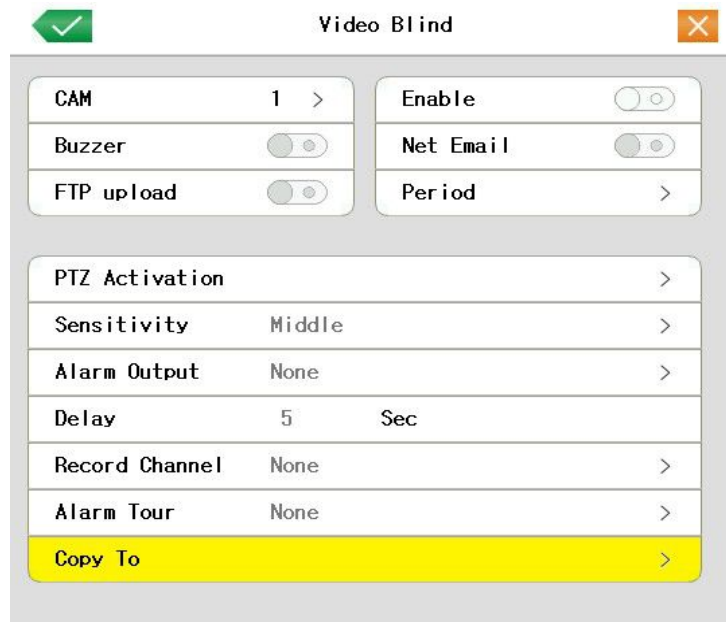

Picture 4.9 Video Blind

Set method: refer to chapter 4.3.1. Motion detect

4.3.3 Video Loss

When the equipment can not obtain the channel video signal, the video loss alarm is turned on and the linkage function is turned on.



Picture 4.10 Video loss

Set method: refer to chapter 4.3.1. Motion detect

4.3.4 Alarm input

When the equipment obtains the external alarm signal, the alarm function is turned on.

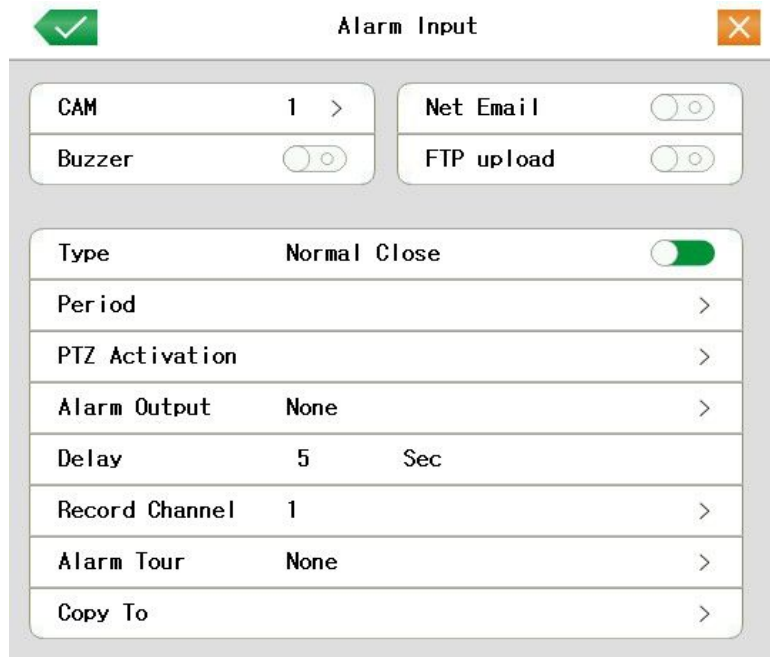

Picture 4.11 Alarm input

Set method: refer to chapter 4.3.1. Motion detect

4.3.5 Abnormal

Analysing and inspecting current software and hardware of the device: When some abnormal events happen, the device will make a relative answer such as show message and buzzer.

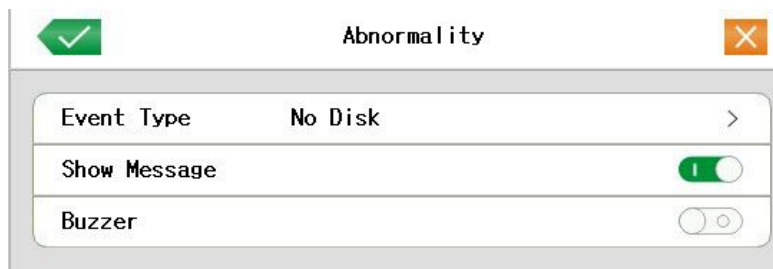

Picture 4.12 Abnormal

- 【Event Type】** selecting abnormality you want to inspect
- 【Enable】** Select  to make sure abnormal function workable
- 【Show message】** Automatically alarm cue shows on the main screen
- 【Buzzer】** Device will have two long nosie “di di” while alarm is happening

4.4 System setup

Set the system parameters such as **General, Encode, NetWork, NetService, GUI display, PTZ config, Add IPC, Tour, System time, Video standard, Resolution, Wireless, Color setting, PTZ control.**

4.4.1 General

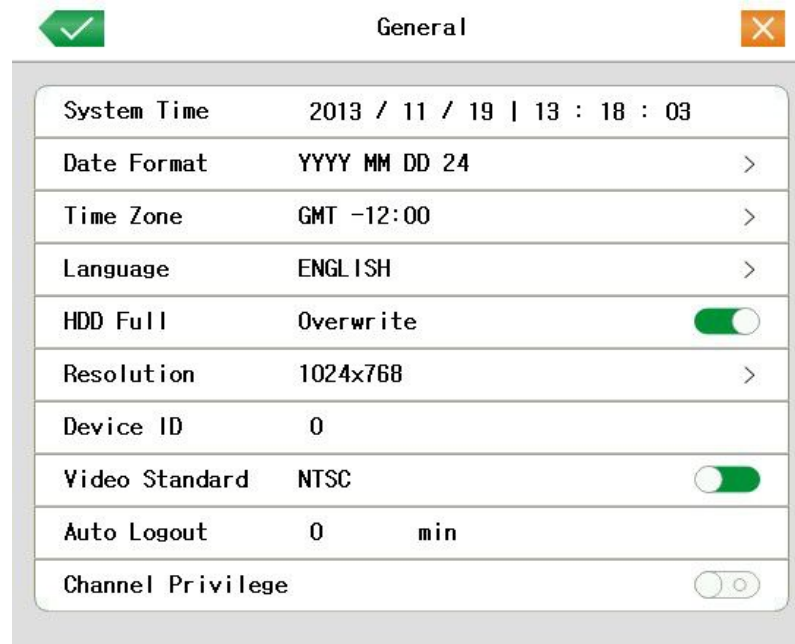

Picture 4.13 General setup

【System time】 Set the system data and time.

【Date format】 Choose the data format: YMD, MDY, DMY.

【Time Zone】 Choose time zone.

【Language】 Support multiple languages with Chinese and English as standards

【HDD full】 Choose stop record: Stop recording when the hard disk is full.

Choose overwrite: Cover the earliest recording files and continue recording when the hard disk is full.

【Resolution】 Set display resolution and mode.

【NVR No.】 Only when the address button in the remote controller and the corresponding NVR number is matched, the remote operation is valid.

【Video Standard】 PAL or NTSC.

【Auto Logout】 Set the latency time in 0-60. 0 means no latency time.

4.4.2 Encode setup

Set the video/audio code parameter: video file, remote monitoring and so on. Set every independent channel's coding parameter in the left part, and set the combine encode parameter in the right part.

Note: Combine encode introduces video compression technique which combines and compresses multi-channel's video to a special channel. Applying for multi-channel playback simultaneously, Dial-up multi-channel real-time monitor, mobile monitor and so on.

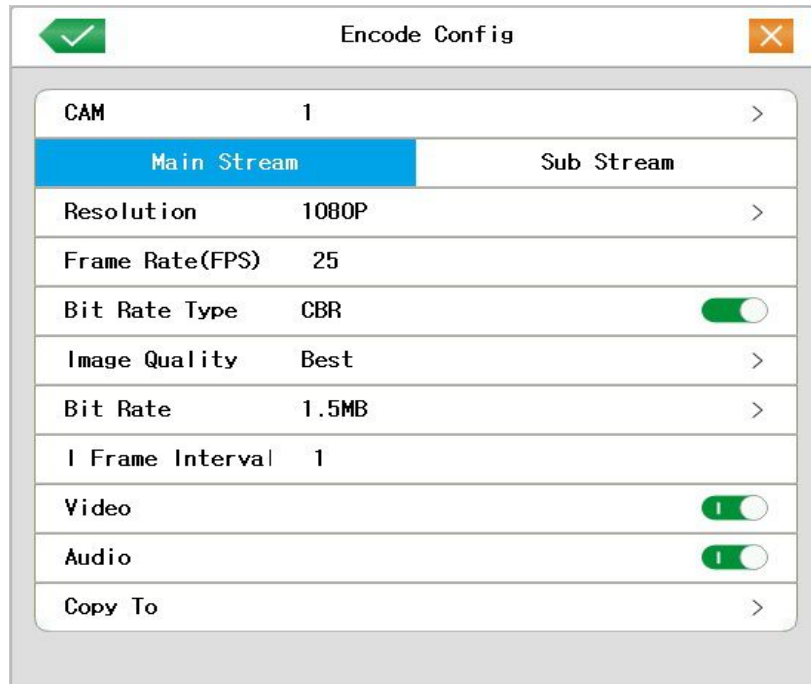

Picture 4.16 Encode setup

【CAM】 Choose the channel number.

【Compression】 Standard H.264 main profile.

【Resolution】 Show resolution of connected ipc:1080P/960P/720P/D1/ HD1/CIF / QCIF.

【Frame Rate】 P:1 frame/s~25 frame/s; N: 1 frame/s~30 frame/s

【Bit Rate】 Set the code stream value to modify the image quality. The larger code stream value the better image quality.

D1 (1000~1500kbps) ,CIF (384~1500kbps) , QCIF(64~512kbps)

【Video/Audio】 When the icons are all selected, the video file is video and audio multiplex stream.

Combine Enable

【Combine Enable】 When the icons are all checked, opening combination coding functions.

【 Mode 】 multi-channel playback is used in all channels playback simultaneously, and the narrowband transmission is used in multi-channel real-time remote monitoring simultaneously at

narrowband state, especially used in mobile monitor.

4.4.3 Network setup

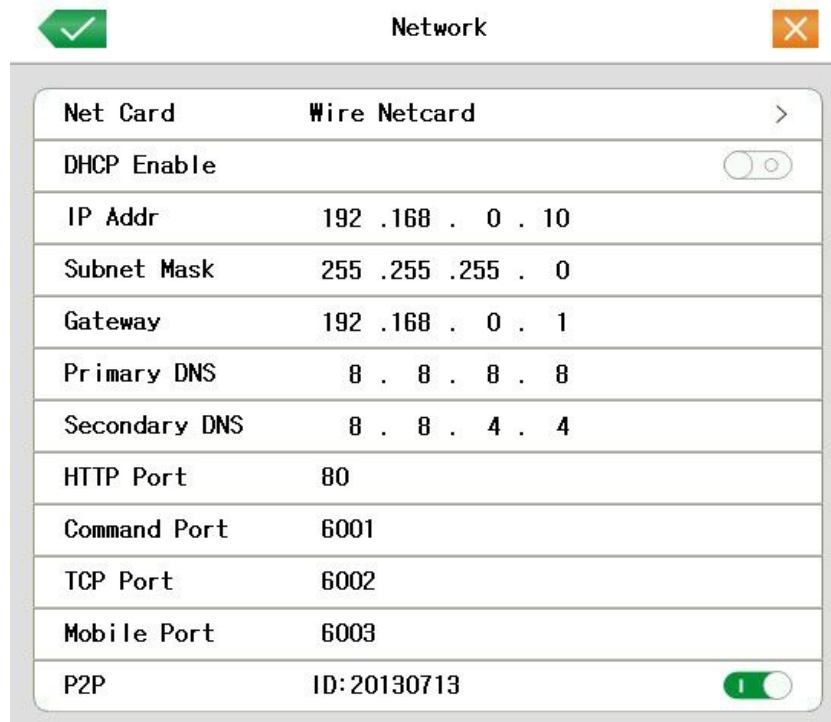

| Net Card | Wire Netcard | > |
|---------------|-------------------|-------------------------------------|
| DHCP Enable | | <input type="checkbox"/> |
| IP Addr | 192 .168 . 0 . 10 | |
| Subnet Mask | 255 .255 .255 . 0 | |
| Gateway | 192 .168 . 0 . 1 | |
| Primary DNS | 8 . 8 . 8 . 8 | |
| Secondary DNS | 8 . 8 . 4 . 4 | |
| HTTP Port | 80 | |
| Command Port | 6001 | |
| TCP Port | 6002 | |
| Mobile Port | 6003 | |
| P2P | ID: 20130713 | <input checked="" type="checkbox"/> |

Picture4.17 Network

【Net Card】 You can choose cable network card or wireless network card.

【DHCP Enable】 Obtain IP address automatically(not suggested)

Note: DHCP server is preinstalled.

【IP address】 Set the IP address. Default: 192.168.0.10.

【Subnet mask】 Set the subnet mask code. Default: 255.255.255.0.

【Gateway】 Set the default gateway. Default: 192.168.0.1.

【DNS setup】 Domain Name Server. It translates the domain name into IP address. The IP address is offered by network provider. The address must be set and reboot then it works.

【HTTP port】 Default: 80.

【Command port】 Default port:6001

【TCP port】 Default: 6002.

【Mobile Monitor port】 Default: 6003

【P2P】 Enable or disable p2p function.

4.4.4 NetService

Choose the network service option and click the set button to configure the parameters.



Picture 4.18 NetService

【PPPoE setup】

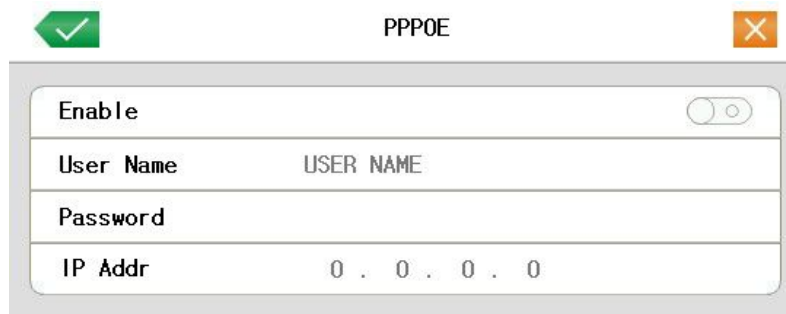

Picture4.19 PPPOE

Input the user name and password that ISP (Internet service provider) provides. After saving it reboot up your system. Then the NVR will build a network connection based on PPPoE. The IP address will change into dynamic IP address after above operation is well done.

Operation: After PPPoE dialing successfully look up the IP address in the [IP address] and obtain the current IP address. Then use this IP address to visit the NVR through user port.

【NTP setup】

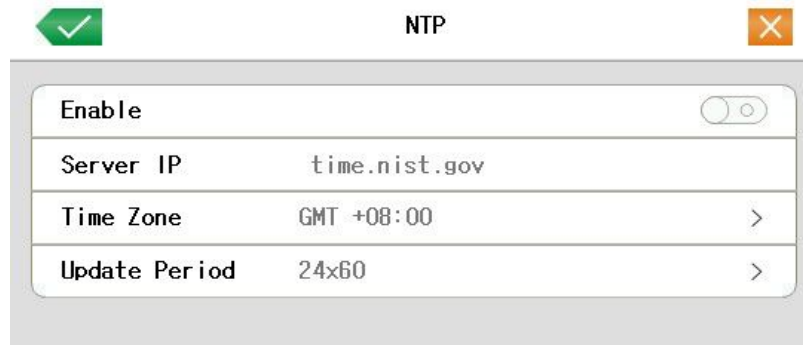

Picture 4.20 NTP

The NTP server must be installed in the PC.

Server IP: Input the IP address installed NTP server.

Port: Default: 123. You can set the port according to NTP server.

Time zone: London GMT+0 Berlin GMT +1 Cairo GMT +2 Moscow GMT +3 New Delhi GMT +5 Bangkok GMT +7 Hongkong Beijing GMT +8 Tokyo GMT +9 Sydney GMT +10 Hawaii GMT-10 Alaska GMT-9 Pacific time GMT-8 American mountain time GMT-7 American mid time GMT-6 American eastern time GMT-5 Atlantic time GMT-4 Brazil GMT-3 Atlantic mid time GMT-2.

Update Period: The same with the NTP server check interval.

【EMAIL setup】

If the alarm is turned on or the alarm linkage photos are taken, send an email about the alarm information and the photos to appointed address.

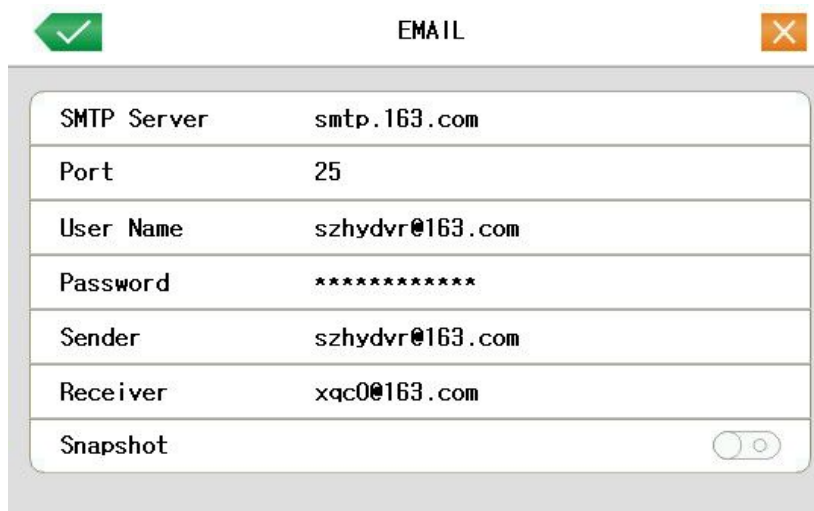

Picture 4.21 EMAIL

SMTP server: Email server address. It could be an IP address or domain name. Domain name can be translated only it is the correct DNS configuration.

Port: Email server port number.

User Name:Apply the email server user name.

Password:Input the password corresponding to the user.

Sender:Set the email sender address.

Receiver:Send the email to appointed receivers when the alarm is turned on. You can set three receivers at most.

Snapshot:Enable or disable alarm snapshot.

【DDNS】

It is the abbreviation of dynamic domain name server.

DDNS Type:choose ddns service provider.

User name: Provide the account registered by DDNS.

Password: Provide the password registered by DDNS.

When the DDNS is successfully configured and start, you can connect the domain name in the IE address column to visit.

Domain name: Provide the domain name registered by DDNS.

Note: The DNS setup must be configured correctly in the network setup.



| DDNS | |
|-----------|-------------------------------------|
| Enable | <input checked="" type="checkbox"/> |
| DDNS Type | member.3322.org > |
| User Name | xqc1974 |
| Password | ***** |
| Server IP | xqc1974.3322.org |

Picture 4.23 DDNS setup

【FTP setup】 FTP is available only when alarm happens, or alarm activates record and snapshot, it will upload related snapshot pictures to FTP server.

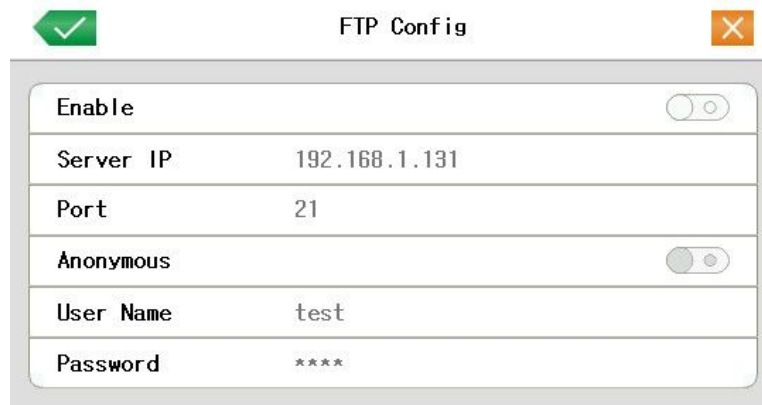

| FTP Config | |
|------------|--------------------------|
| Enable | <input type="checkbox"/> |
| Server IP | 192.168.1.131 |
| Port | 21 |
| Anonymous | <input type="checkbox"/> |
| User Name | test |
| Password | **** |

Picture 4.24 FTP setup

【Enable】 Click Enable,then all settings will be available

【Server IP】 IP address for FTP server

【Port】 Domain Port of FTP,default 21

【User Name】 User name of FTP

【Password】 Password of user

【UPNP】 UPNP protocol can auto port forwarding on router,make sure UPNP is running on router before use it.

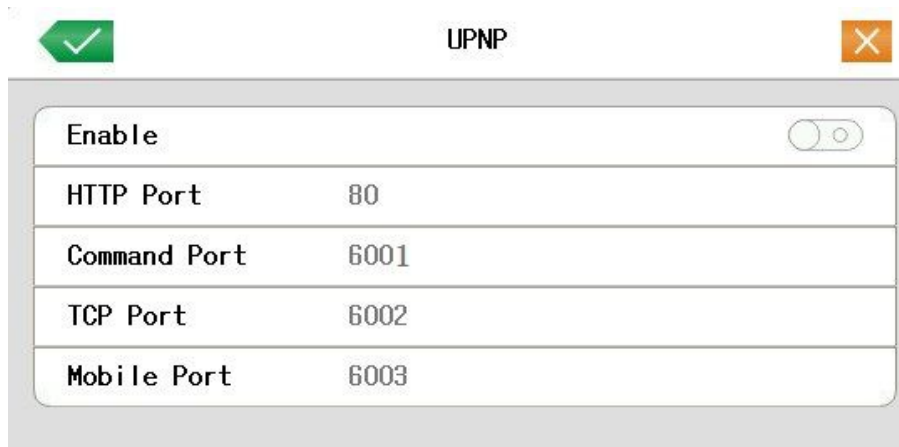

Picture 4.27

【Enable】 Choose Enable to make sure all UPNP settings available

【ARSP】 Domain name auto register.



Set your user name,click “Enter(Confirm)” to register ,click  to save.If successful,you will get the domain name : username.edvrddns.com

Make sure the network setup is correct before setting up ARSP.When the ARSP is successfully configured and start, you can input the domain name in the IE address column to visit.

【Wireless Config】 ADSL through usb 3G net card

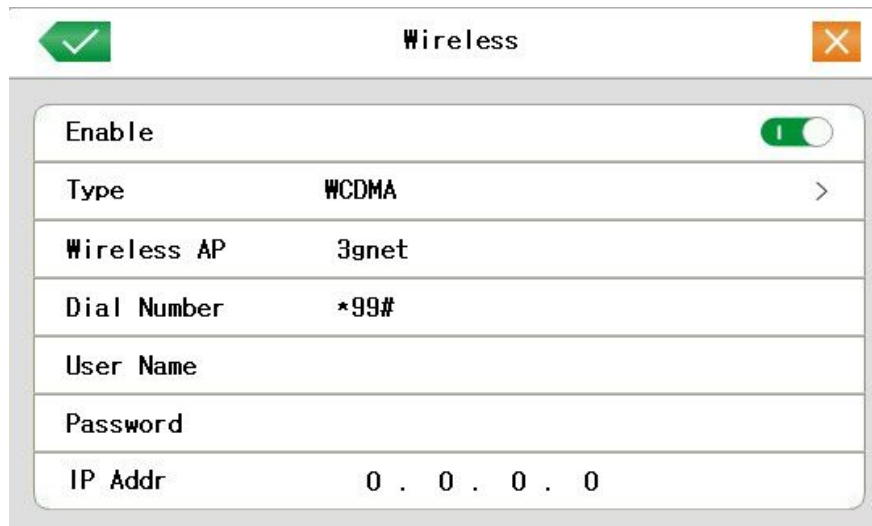

Picture 4.25 Wireless Config

【Enable】 Choose Enable to make all settings available

【Type】 Dial type,default AUTO

【Wireless AP】 3G access point

【Dial Number】 3G Dial Number

【User Name】 User name of 3G

【Password】 Password of dial user

【IP Address】 IP address,got from dial

【Wifi】 wireless connection through usb wifi net card



4.4.5 GUI Display

Configure the video output parameters including the front output mode and code output mode.

Front output: In the local preview mode include: channel title, time display, channel title, record status, alarm status, bitrate info, transparency and region cover.

Code output: In the network surveillance and video file mode include: channel title, time display, channel title, record status, alarm status, bitrate info, transparency and region cover.

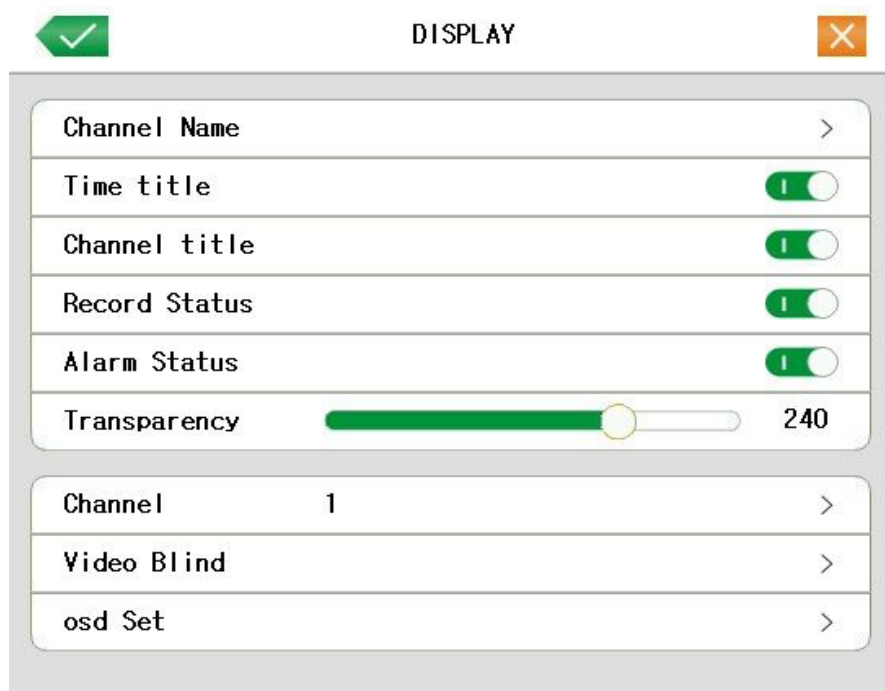



Picture 4.28 GUI Display

【Channel Title】 Click the channel name modify button and enter the channel name menu. Modify the channel name. The 16 Chinese characters and 25 letters are supportive.

【Time Display】  means the selective state. Display the system data and time in the surveillance window.

【Channel Title】  means the selective state. Display the system channel number in the surveillance window.

【Record Status】  means the selective state. Display the system recording status in the surveillance window.

【Alarm Status】  means the selective state. Display the system alarm status in the surveillance window.

【Transparency】 Choose the background image transparency. The range is 75~255.

【Channel】 Choose the set code output channel number.

【Region Cover】 Click **set** button and enter the corresponding channel window. You can cover the arbitrary using mouse. (Gray region is for output)

【Time display】 and 【Channel Title】 Set osd position of time title and channel title.

4.4.6 PTZ setup

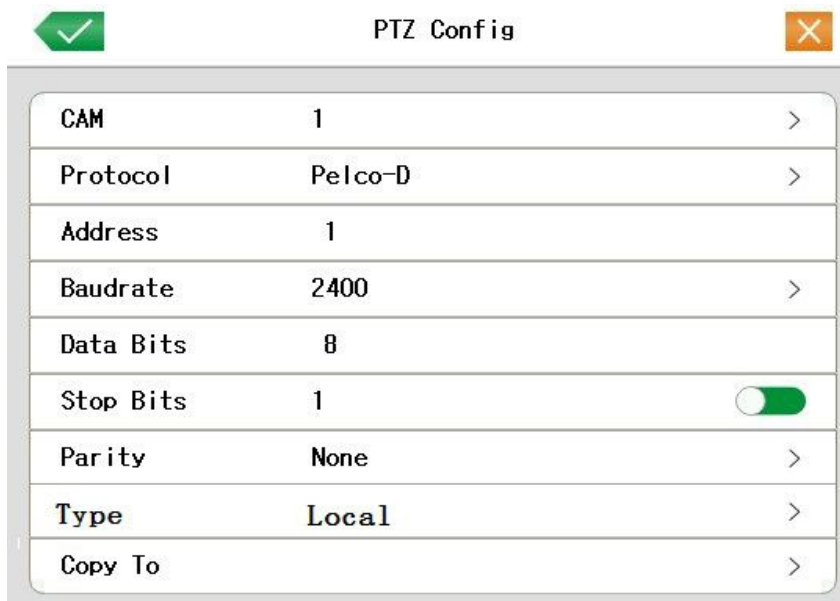

The screenshot shows a 'PTZ Config' window with a green checkmark icon on the top left and an orange close icon on the top right. The window contains a list of settings for PTZ configuration:

| | | |
|-----------|---------|-------------------------------------|
| CAM | 1 | > |
| Protocol | Pelco-D | > |
| Address | 1 | |
| Baudrate | 2400 | > |
| Data Bits | 8 | |
| Stop Bits | 1 | <input checked="" type="checkbox"/> |
| Parity | None | > |
| Type | Local | > |
| Copy To | | > |

Picture 4.29 PTZ setup

【Channel】 Choose the dome camera input channel.

【Protocol】 Choose the corresponding dome protocol. (PELCO-D as an example)

【Address】 Set as the corresponding dome address. Default: 1. (Note: The address must be consistent with the dome address.)

【Baudrate】 Choose the corresponding dome baud rate length. You can control the PTZ and vidicon. Default: 2400.

【Data bits】 Include 5-8 options. Default: 8.

【Stop bits】 Include 2 options. Default: 1.

【Parity】 Include odd check, even check, sign check, blank check. Default: void.

【Device type】 Select "Local" if using 485 to control PTZ. Select "Distance" if using onvif.

4.4.7 Add IPC

Search and add ip cameras to nvr. For more details, refer to chapter 3.3.

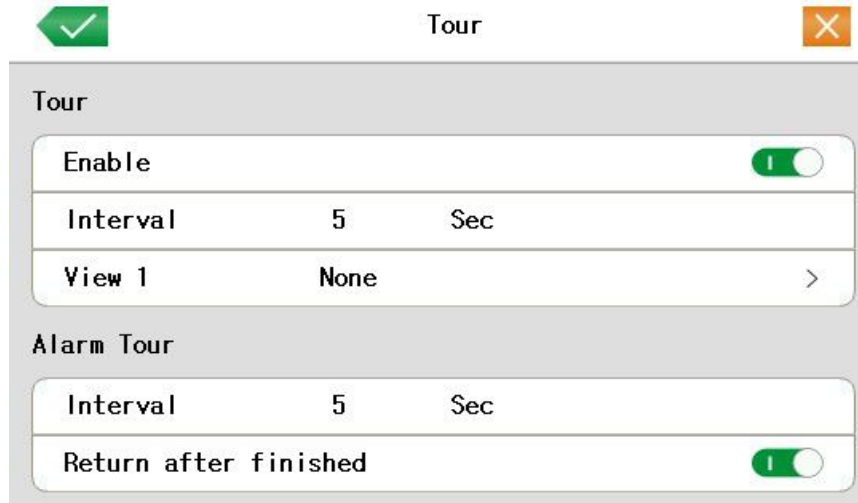

4.4.8 Tour setup

Set the patrol display.  means that the tour mode is turned on. You can choose the single window, four windows, nine windows, sixteen windows patrol display or single display.



Picture 4.31 tour setup

【interval】 Set the patrol switch interval. The set range is 5-120 seconds.

Note:  /  means turn on/off the patrol.

4.4.9 System Time

Link to “General” to set system time.Refer to 4.4.1General

4.4.10 Video standard

Link to “General” to set video standard.Refer to 4.4.1General.

4.4.11 Resolution

Link to “General” to set display resolution.Refer to 4.4.1General.

4.4.12 Wireless

ADSL through usb 3G net card.Refer to 4.4.4net service--wireless.

4.4.13 Color setting

Refer to 3.5.4Color setting.

4.4.14 PTZ control

Refer to 3.5.3PTZ control.

4.5 Advanced

4.5.1 HDD Manage

Configure and manage the hard disk. The menu displays current hard disk information: hard disk number, status and overall capability. We can format the disk here. Choose the hard disk and click the right function button to execute.

Clue:Status “Normal” means that the hard disk is normal. “Error” means that the hard disk is broken-down. If the user need to change the damaged hard disk, you must shut down the NVR and take up all the damaged hard disks,then install a new one.

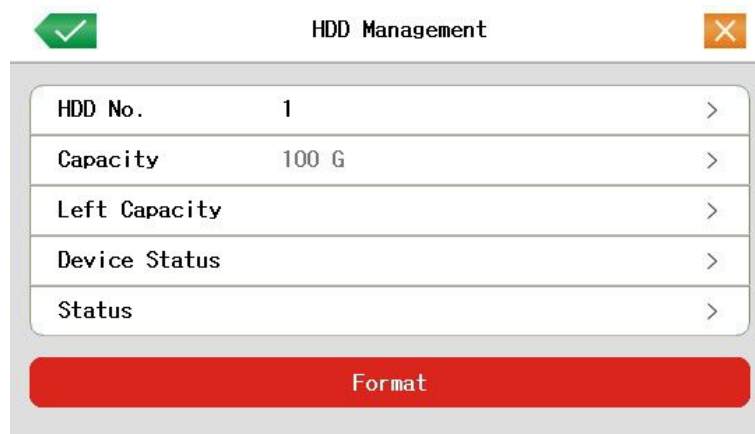

Picture4.32 HDD Manage

4.5.2 Account

Manage the user purview.



Picture 4.33 Account

【Modify User】 Modify the existed user attribute.

【Modify Password】 Modify the user password. You can set 1-6 bit password. The blank ahead or behind the char string is invalid. The middle blank in the char string is valid.

Note: The user who possess the user control purview can modify his/her own or other users password

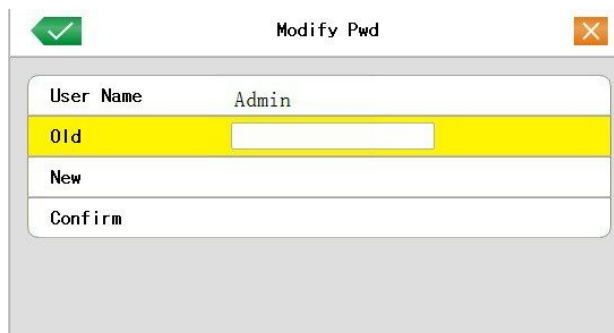

Picture 4.34 Modify Password

【Add user】 Add a user in the team and set the user purview. Enter the menu interface and input the user name and password. Choose the team and choose whether cover using the user. Cover using means that the account can be used by multiple users at the same time.

Once choose the team the user purview is the subclass of the team.

We recommend that the common user's purview is lower than the advanced user.

Picture 4.35 add user

【Delete User】 Delete the current user. Choose the user and click delete user button.

4.5.3 Online User

Look up the network user information in the local NVR. You can choose the network user and cut the connection. Then the user is locked until next boot-strap.

| Index | User Name | IP | Login Type |
|-------|-----------|----|------------|
| | | | |

Picture 4.38 Online User

4.5.4 TV adjust

Refer to chapter 3.5.5 .

4.5.5 Auto Maintain

The user can set the auto reboot time .

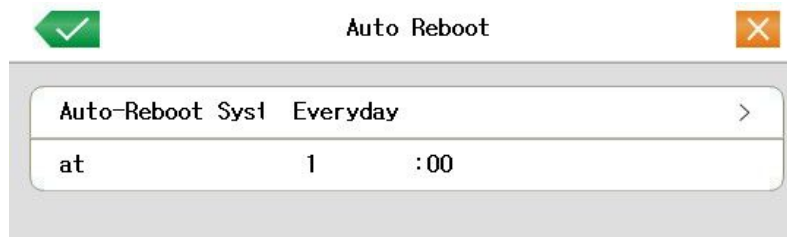

Picture 4.39 Auto maintain

4.5.6 Restore

The system restore to the default setup.

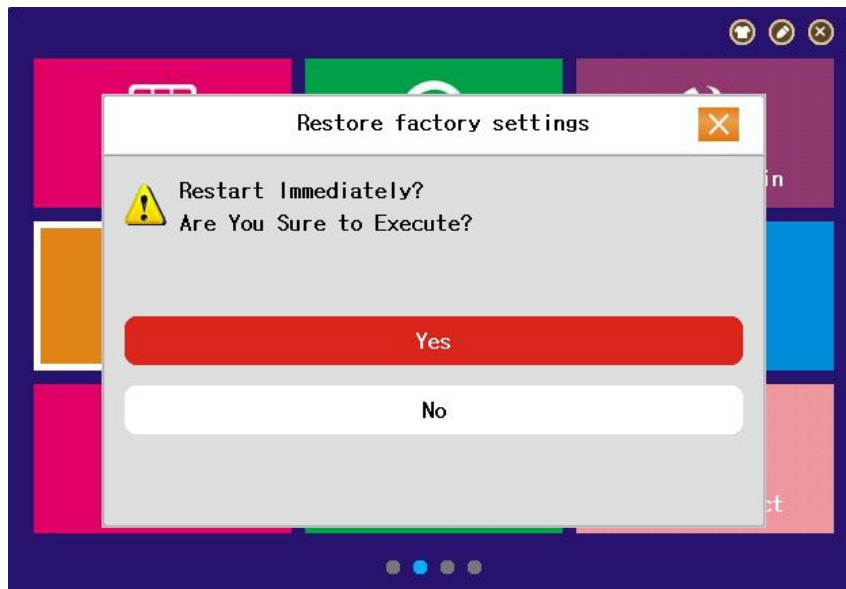

Picture 4.40 Restore

4.5.7 Upgrade



Picture 4.41 Upgrade

【Upgrade】 choose USB interface.

【Upgrade file】 choose the file which needs upgraded.

4.5.8 Device Info

Provide device interface info like audio in,alarm in/out to be conveniently used for user.

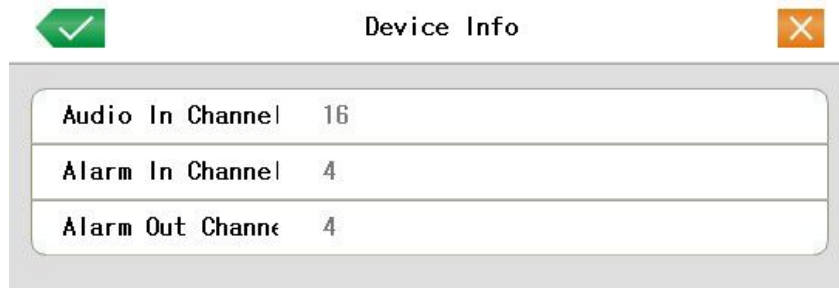

Picture 4.42 Device Info.

4.6 Info

4.6.1 LOG

Look up system log according to the set mode.

Log information include: system operation, configuration operation, data management, alarm affair, recording operation, user management, file management and so on. Set the time section to look up and click the look up button. The log information will display as a list.

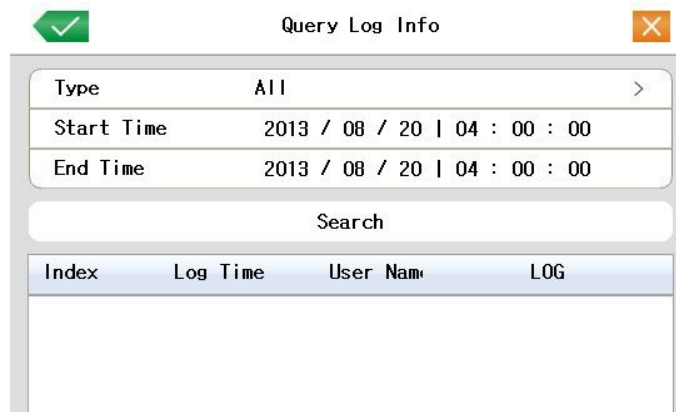

Picture4.41 LOG

4.6.2 Version

Display the basic information such as hardware information, software edition, serial number and so on.

Version ✕

| | |
|----------------|---------------------|
| Record Channel | 16 |
| Extra Channel | 0 |
| Alarm Input | 4 |
| Alarm Output | 4 |
| System | 2.3.54 |
| Build Date | 2013-08-20 09:00:00 |
| SerialNo | 00-01-43-22-38-10 |

Picture 4.42 Version

4.7 Entertainment

Click "Game" . Built-in "Tetris".

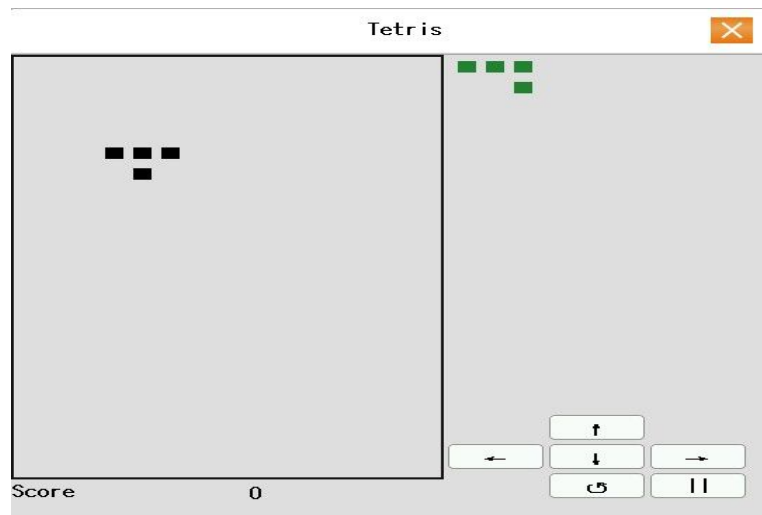

4.8 Shut down system

Refer to chapter 3.5.6.

5 FAQ and maintenance

5.1 FAQ

If the problems are not listed, please contact the local service or call the HQ service. We are willing to offer the service.

1、 The NVR can not boot up normally.

Possible reasons are as followed:

- 1 The power supply is not correct.
- 2 Switch power supply line is not in good connection.
- 3 Switch power supply is damaged.
- 4 The program updating is wrong.
- 5 The hard disk is damaged or the hard disk lines are broken.
- 6 The front panel is damaged.
- 7 The main board of the NVR is damaged.

2、 The NVR reboots automatically or stops working after boot up a few minutes.

Possible reasons are as followed:

- 1 The input voltage is not stable or too low.
- 2 The hard disk is damaged or the hard disk lines are broken.
- 3 The power of the switch power supply is low.
- 4 Frontal video signal is not stable.
- 5 Bad heat radiator or too much dust or bad running circumstance for the NVR.
- 6 The hardware of the NVR is damaged.

3、 System can not detect hard disk.

Possible reasons are as followed:

- 1 The hard disk power supply line is not connected.
- 2 The cables of the hard disk are damaged.
- 3 The hard disk is damaged.
- 4 The SATA port of main board is damaged.

4、 There are no video outputs in single channel, multiple channels and all channels.

Possible reasons are as followed:

- 1 The program is not matched. Please update the program.
- 2 The image brightness is all 0. Please restore the default setup.
- 3 There is no video input signal or the signal is too weak.
- 4 The channel protection or the screen protection is set.
- 5 The hardware of the NVR is damaged.

5、 I can not find the video files in local playback mode.

Possible reasons are as followed:

- 1 The data line of the hard disk is damaged.
- 2 The hard disk is damaged.
- 3 Update the different program with the origin program files.
- 4 The video files to look up are covered.
- 5 The recording is not on.

6、 The local video is not clear.

Possible reasons are as followed:

- 1 The image quality is too bad.
- 2 The reading program is wrong. Reboot up the NVR.
- 3 The data line of the hard disk is damaged.
- 4 The hard disk is damaged.
- 5 The hardware of the NVR is damaged.

7、 There is no audio signal in the surveillance window.

Possible reasons are as followed:

- 1 It is not an active tone arm.
- 2 It is not an active sound box.
- 3 The audio lines are damaged.
- 4 The hardware of the NVR is damaged.

8、 There is audio signal in the surveillance window but no audio signal in the playback state.

Possible reasons are as followed:

- 1 Setting issues: the audio option is not chosen.

2 The according channel is not connected with the video.

9、 The time is wrong.

Possible reasons are as followed:

- 1 Setting is wrong..
- 2 The battery is in bad connection or the voltage is too low.
- 3 The oscillation is damaged.

10、 The NVR can not control the PTZ.

Possible reasons are as followed:

- 1 There is something wrong with the frontal PTZ.
- 2 The setting, connection or the installation of the PTZ decoder is not correct.
- 3 The connections are not correct.
- 4 The PTZ setting of the NVR is not correct.
- 5 The protocols of the PTZ decoder and the NVR are not matched.
- 6 The address of the PTZ decoder and the NVR are not matched.
- 7 When multiple decoders are connected, the far port of the PTZ decoder line A(B) must connect a 120 Ω resistance to reduce the reflection otherwise the PTZ control is not stable.
- 8 The distance is too far.

11、 The motion detect is not working,

Possible reasons are as followed:

- 1 The time range set is not correct.
- 2 The motion detect area set is not correct.
- 3 The sensitivity is too low.
- 4 Limited by some hardware edition.

12、 I can not login via web or CMS.

Possible reasons are as followed:

- 1 The system is windows 98 or win me. We recommend updating to windows 2000sp4 or higher Version or installing the software for low edition.
- 2 ActiveX is hold back.
- 3 The version is not exceeded dx8.1. Update the display card driver.

- 4 Network connection failure.
- 5 Network setting issues.
- 6 Invalid password or user name.
- 7 The CMS is not matched the NVR program version.

13、 The image is not clear or there is no image in network preview state or video file playback state.

Possible reasons are as followed:

- 1 Network is not stable.
- 2 The user machine is resource limited.
- 3 Choose the play-in-team mode in the network setup of NVR.
- 4 The region shelter or channel protection is set.
- 5 The user has no surveillance purview.
- 6 The real-time image of the hard disk recording machine itself is not clear.

14、 Network connection is not stable.

Possible reasons are as followed:

- 1 Network is not stable.
- 2 IP address is conflicted.
- 3 MAC address is conflicted.
- 4 The net card of the NVR is bad.

15、 There is something wrong with the USB backup or writing a CD.

Possible reasons are as followed:

- 1 The rewritable machine and the hard disk are shared the same data lines.
- 2 The data is too much. Please stop recording and backup.
- 3 The data exceeds the backup storage.
- 4 The backup equipment is not compatible.
- 5 The backup equipment is damaged.

16、 The keyboard can not control the NVR.

Possible reasons are as followed:

- 1 The serial port of the NVR is not set correctly.
- 2 The address is not correct.

3 When multiple transformers are connected, the power supply is not large enough. Please give each transformer individual power supply.

4 The distance is too far.

17、 Alarm can not be recessional.

Possible reasons are as followed:

1 The setting of the alarm is not correct.

2 The alarm output is turned on manually.

3 The input machine is damaged or the connections are not correct.

4 There are some problems for specific program edition, Please update the program.

18、 Alarm is not working.

Possible reasons are as followed:

1 The setting of the alarm is not correct.

2 The connection of the alarm is not correct.

3 The alarm input signal is not correct.

4 A alarm is connected with two loops synchronously.

19、 The remote controller is not working,

Possible reasons are as followed:

1 The remote control address is not correct.

2 The remote control distance is too far or the angle is too large.

3 The battery is used up.

4 The remote controller or the front panel of the recording machine is damaged.

20、 The storage time is not enough.

Possible reasons are as followed:

1 Front vidicon quality is bad. The lens is too dirty. The vidicon is in backlighting installation.

2 The hard disk capability is not enough.

3 The hard disk is damaged.

21、 The downloading files can not play.

Possible reasons are as followed:

1 There is no media player.

2 There is no DX8.1 software or higher edition.

- 3 There is no DivX503Bundle.exe file to play AVI video files.
- 4 The DivX503Bundle.exe and ffdshow-2004 1012 .exe files must be installed in the windows xp system.

22、 **I can not remember the advanced code or network code in the local menu operation.**

Please contact the local service or call the HQ service. We will offer the service according the machine type and the program edition.

5.2 Maintenance

- 1 Please brush printed circuit boards, connectors, fans, machine box and so on regularly.
- 2 Please keep the grounding well done to prevent the video or audio signal interfered and the NVR from static or inductive electricity.
- 3 Do not pull out the video signal line or RS-232 port or RS-485 port with the power on.
- 4 Do not use the TV in the local video output port(VOUT) of NVR. It will damage the video output circuit easily.
- 5 Do not turn off the switch directly. Please use the turn-off function in the menu or press the turn-off button in the panel (3 seconds or longer) to protect the hard disk.
- 6 Please keep the NVR away from heat resource.
- 7 Please keep the NVR ventilated for better heat radiator.

Please check the system and maintain regularly.

Appendix 1.Remote controller operation

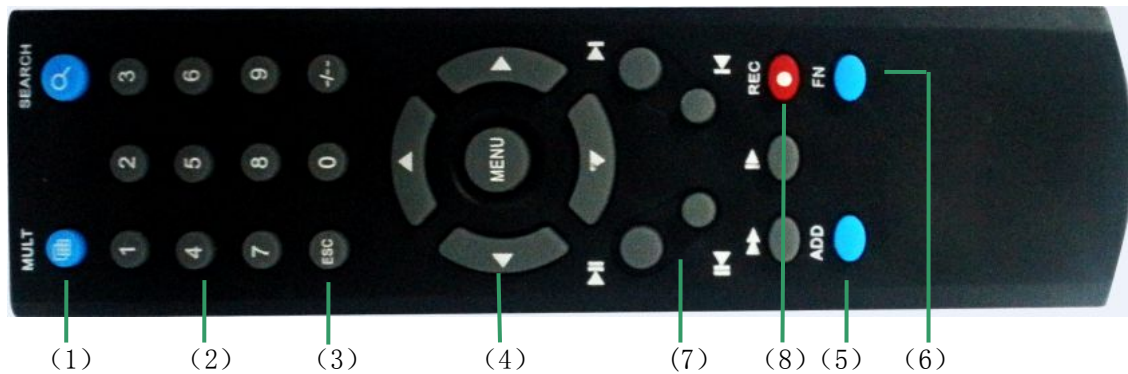

| Serial number | Name | Function |
|---------------|---------------------|---|
| 1 | Multi-window button | Same function as Multi-window button in the front panel |
| 2 | Numeric button | Code input/number input/channel switch |
| 3 | 【Esc】 | Same function as 【Esc】 button in the front panel |
| 4 | Direction button | Same function as direction button in the front panel |
| 5 | ADD | Input the number of NVR to control it |
| 6 | FN | Assistant function |
| 7 | Playback control | Basic operations in playback |
| 8 | Record mode | Get in record setup menu |

Appendix 2. Mouse operation

***Take right hand as an example**

The mouse in USB connection is supported.

| Operation | Function |
|-------------------|--|
| Double left click | Double click the playback video to zoom in or out the screen |
| | Double click the channel to make it full screen display double click again to goto next channel |
| Left click | Choose the according function in the menu |
| Right click | Pop desktop shortcut menu in preview state |
| | Switch to full screen view when playback |
| Move mouse | Choose the widget or move the item in the widget |
| Drag mouse | Set the motion detect area |
| | Set the cover area |

Appendix 3.Hard disk capability calculation

Make sure the hard disk installed to the NVR for the first time. Pay attention to the IDE hard disk lines connection.

1、 Hard disk capability

There is no limit for recording machine. We recommend 500G~1000G size to keep better stability.

2、 Overall capability option

The hard disk capability formula is:

Overall capability (M) =channel number*time (hour) *capability in an hour (M/hour)

The recording time formula is:

$$\text{Recording time (hour)} = \frac{\text{overall capability (M)}}{\text{Capability in an hour (M/hour) *channel number}}$$

The NVR introduces the H.264 compression technology. Its dynamic range is very large so the hard disk capability calculation is based on the estimation values of each channel creating files in an hour.

Example:

For one piece 1000G HDD,4 cameras record at 3Mbps,it will keep recording for about 7.7 days.HDD spaces per channel is 1350M/H,if 4channels with 3Mbps at 24hours recording uninterrupted,it can last:1000G/(1350M/H*24H*4ch)=7.7 days

Bit Rate Conversion:

1 Byte= 8 bit ,1MB = 1024KB ,1Hour = 3600secs

1 Kbps = 1/8 KBps = 1/8/1024 MBps = (1/8/1024) *3600 MB/H

1 Mbps = 1/8 MBps = (1/8) * 3600 MB/H = 450M/H

Appendix 4.Mobile Connection

1.Software download

Android:Android devices can directly download the software “Smart mEye”from google play .Or you can get it from the CD.

Iphone:IOS devices can directly download the software “Smart mEye”from app store.

2.Mobile connection

Install the software on your mobile phone after setting remote surveillance.

Name: Any characters you like.Please don’t use name that already existed in the device list.

Address: Target’s IP address,URL or ID.Please note that if url is used,the “http://” prefix should not be included.

Port: Mobile port in NVR.

User/Password: the same as that on NVR.

Channel number: total number of channels.

For detailed instructions,please read the super meye user manual in the cd .

